



*Celebrating 15 Years of Excellence*

# 2020 PRODUCT CATALOGUE

THE TRUSTED LEADER IN QUALITY FLAME & ARC RESISTANT WORKWEAR



## CONTENTS

<b>Introduction to IFR Workwear Inc.</b> .....	1
<b>Aboriginal Commitment</b> .....	2

### Women's Workwear ..... 3

Style 452 - UltraSoft® 7 oz Suit-All Top.....	5
Style 453 - UltraSoft® 7 oz Suit-All Bottom.....	5
Style 471 - Women's UltraSoft® 7 oz Deluxe Segmented Striped Work Shirt.....	6
Style 671 - Women's UltraSoft® 7 oz Cargo Pants.....	7
Style 474 - Women's Segmented Striped Fleece Full Zip Jacket.....	8
Style 750 - Women's IFR BaseWear Top.....	9
Style 760 - Women's IFR BaseWear Bottom.....	9

### IFR Workwear - 15 Years of Excellence ..... 10

### High Visibility ..... 11

Style 408 - UltraSoft® 7 oz Deluxe Coveralls.....	13
Style 409 - UltraSoft® 9 oz Deluxe Coveralls.....	14
Style 452 - UltraSoft® 7 oz Suit-All Top.....	15
Style 453 - UltraSoft® 7 oz Suit-All Bottom.....	15
Style 422 - UltraSoft® 9 oz Bib Pants.....	16
Style 651 - UltraSoft® 7 oz Deluxe Striped Work Shirt.....	17
Style 652 - UltraSoft® 7 oz Deluxe Segmented Striped Work Shirt.....	17
Style 661 - UltraSoft® 6 oz Henley Striped Long Sleeve T-Shirt.....	18
Style 662 - UltraSoft® 6 oz Henley Segmented Striped Long Sleeve T-Shirt.....	18
Style 327 - Striped Fleece Pullover.....	19
Style 329 - Segmented Striped Fleece Full Zip Jacket.....	20
Style 413 - UltraSoft® 7 oz Shell Jacket.....	21
Style 417 - UltraSoft® Quilted Freezer Jacket.....	22
Style 513 - 3 in 1 Parka.....	23
Style 515 - UltraSoft® 9 oz Insulated Parka.....	24
Style 525 - UltraSoft® 9 oz Insulated Bib Pants.....	24
Style 1130 - UltraSoft® 7 oz FR Surveyor Vest.....	25
Style 1715 - UltraSoft® 7 oz FR Yard Vest.....	26
Style 1715 - (Non-FR) Mesh Yard Vest.....	27
Style 7215SJ - FlexArc 10 oz Polyurethane/FR Cotton Rain Jacket.....	28
Style 7215BT - FlexArc 10 oz Polyurethane/FR Cotton Bib Pants.....	28

### 3M™ - Create a More Visible World ..... 29

### Avenger by IFR ..... 31

Style 3108 - Avenger 7 oz Coveralls.....	33
Style 3122 - Avenger 12 oz Duck Bib Pants.....	34
Style 3610 - Avenger 12 oz Duck Work Pants.....	35
Style 1250 - Avenger 7 oz FR Surveyor Vest.....	36
Style 3215 - Avenger 9 oz Insulated Parka.....	37
Style 3225 - Avenger 9 oz Insulated Bib Pants.....	37

### Avenger Winterwear - Stay Warm This Winter ..... 38

### Westex UltraSoft® ..... 39

Style 102 - UltraSoft® 7 oz Deluxe Coveralls.....	41
Style 106 - UltraSoft® 9 oz Contractor Coveralls.....	42
Style 107 - UltraSoft® 7 oz Contractor Coveralls.....	43
Style 108 - UltraSoft® 7 oz CSA Deluxe Coveralls.....	44
Style 109 - UltraSoft® 9 oz CSA Deluxe Coveralls.....	45
Style 112 - UltraSoft® 9 oz Skyline Summer Bomber.....	46
Style 150 - UltraSoft® 9 oz Suit-All Top.....	47
Style 151 - UltraSoft® 9 oz Suit-All Bottom.....	47
Style 122 - UltraSoft® 9 oz Bib Pants.....	48
Style 611 - UltraSoft® 9 oz Cargo Pants.....	49
Style 612 - UltraSoft® 7 oz Cargo Pants.....	49
Style 650 - UltraSoft® 7 oz Deluxe Work Shirt.....	50
Style 650 - UltraSoft® 7 oz Deluxe Striped Work Shirt.....	50
Style 660 - UltraSoft® 6 oz Henley Long Sleeve T-Shirt.....	51
Style 201 - UltraSoft® 9 oz Insulated Coveralls.....	52
Style 215 - UltraSoft® 9 oz Insulated Parka.....	53
Style 225 - UltraSoft® 9 oz Insulated Bib Pants.....	53
Style 216 - UltraSoft® 9 oz Insulated Bomber.....	54
Style 240 - UltraSoft® 9 oz Insulated Vest.....	55
Style 265 - UltraSoft® 9 oz Insulated Parka Hood.....	56
Style 275 - UltraSoft® 9 oz Insulated Broiler Hard Hat Liner.....	56
Style 285 - UltraSoft® 9 oz Insulated Hard Hat Liner.....	56
Style 196 - UltraSoft® 9 oz Arm Band.....	57
Style 195 - UltraSoft® 9 oz Leg Band.....	57

### Westex® DH - Designed for Protection ..... 58

### Westex® DH | Nomex® ..... 59

Style 109 - Westex® DH Antistat 6.5 oz Deluxe Coveralls.....	61
Style 122 - Westex® DH Antistat 6.5 oz Bib Pants.....	62
Style 106 - Nomex® IIIA 6 oz Contractor Coveralls.....	63
Style 109 - Nomex® IIIA 6 oz Deluxe Coveralls.....	64
Style 122 - Nomex® IIIA 6 oz Bib Pants.....	65
Style 215 - Nomex® IIIA 6 oz Insulated Parka.....	66
Style 225 - Nomex® IIIA 6 oz Insulated Bib Pants.....	66
Style 216 - Nomex® IIIA 6 oz Insulated Bomber.....	67
Style 265 - Nomex® IIIA 6 oz Insulated Parka Hood.....	68
Style 275 - Nomex® IIIA 6 oz Insulated Broiler Hard Hat Liner.....	68
Style 285 - Nomex® IIIA 6 oz Insulated Hard Hat Liner.....	68

### Davey Textile Solutions Inc. Reflective Trim ..... 69

2020 Edition IFR Workwear Inc. Product Catalogue - Printed March, 2020

Westex UltraSoft®, Westex® DH, Westex® by Milliken® are registered trademarks used under license by IFR Workwear Inc. Nomex® and Nomex® IIIA are registered trademarks of DuPont™ used under license by IFR Workwear Inc. 3M™ and Scotchlite™ are trademarks of 3M™ used under license by IFR Workwear Inc. in Canada.

THE TRUSTED LEADER IN QUALITY FLAME AND ARC RESISTANT WORKWEAR

www.ifrworkwear.ca | 403-347-5480 | info@ifrworkwear.ca

## CONTENTS

<b>Vests</b> .....	<b>71</b>
Style 240 - UltraSoft® 9 oz FR Insulated Vest .....	71
Style 1250 - Avenger 7 oz FR Surveyor Vest .....	71
Style 1130 - UltraSoft® 7 oz FR Surveyor Vest .....	72
Style 1715 - UltraSoft® 7 oz FR Yard Vest .....	72
Style 1715 - (Non-FR) Mesh Yard Vest .....	73
Style 1705 - (Non-FR) Locomotive Engineer O.C.U. Vest .....	73
Style 1710 - (Non-FR) Locomotive Engineer O.C.U. Vest .....	73
Style 1706/1712 - (Non-FR) Insert Panel .....	74
Style 1713-2130 - (Non-FR) Switchlist Pocket .....	74
<b>IFR BaseWear</b> .....	<b>75</b>
Style 750 - Women's IFR BaseWear Top .....	77
Style 760 - Women's IFR BaseWear Bottom .....	77
Style 700 - Men's IFR BaseWear Top .....	78
Style 710 - Men's IFR BaseWear Bottom .....	78
<b>Fleece &amp; Knitwear</b> .....	<b>79</b>
Style 324 - Fleece Full Zip Jacket .....	79
Style 324 - Striped Fleece Full Zip Jacket .....	80
Style 325 - Fleece Pullover .....	81
Style 335 - Reliant® Rib Knit Pullover .....	82
Style 364 - Fleece Hood .....	83
<b>Sample &amp; Return Policy</b> .....	<b>84</b>
<b>Knit Headwear</b> .....	<b>85</b>
Style J62 - Nomex® IIIA 7" Knit Rib Neck Warmer .....	85
Style J63 - Nomex® IIIA Knit Rib Folded Toque .....	85
Style J64 - Nomex® IIIA Knit Rib Beanie .....	85
Style J67 - Nomex® IIIA Knit Rib Balaclava .....	85
Style J56 - Kermel® 7" Knit Rib Neck Warmer .....	86
Style J57 - Kermel® Knit Rib Folded Toque .....	86
Style J58 - Kermel® Knit Rib Balaclava .....	86
Style J59 - Kermel® Knit Rib Beanie .....	86
<b>WeldArmor™ by IFR</b> .....	<b>87</b>
Style 4330 - WeldArmor™ Titanium Jacket .....	89
Style 4331 - WeldArmor™ Pipeliner Jacket .....	90
<b>Accessories</b> .....	<b>91</b>
Style 1750 - Leather Belt .....	91
Style 3110 - PPE Duffle Bag .....	92
Style 1711 - Belt Style Radio Holster .....	92
<b>Services/Support</b> .....	<b>93</b>
<b>Distributor Support Products</b> .....	<b>93</b>
<b>Additional Services</b> .....	<b>94</b>
<b>Technical Information</b> .....	<b>95</b>
<b>Sizing Guidelines</b> .....	<b>95</b>
<b>CSA Z96-15 Standard, Section 4.2.2 (hood provision)</b> .....	<b>96</b>
<b>Standards Boards Reference Guide</b> .....	<b>97</b>
<b>Slick's Tips</b> .....	<b>98</b>

SIGN UP FOR OUR

# eCommerce Store

- Create product lists for each of your customers
- View product stock levels
- Place orders online
- And so much more!

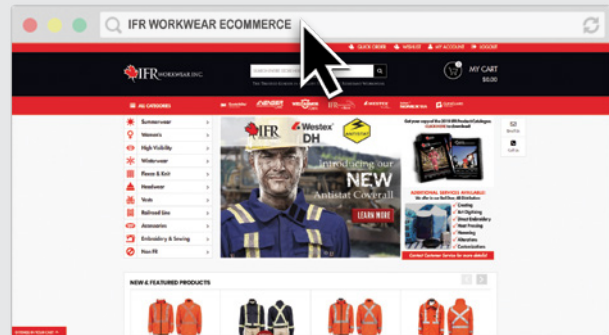

If your company is interested in signing up for our ecommerce store, please contact [ecommerce@ifrworkwear.ca](mailto:ecommerce@ifrworkwear.ca)



## DID YOU KNOW?

You can receive

**New Product Announcements, Specials, Promotions & IFR News**

Simply email us at:

**[info@ifrworkwear.ca](mailto:info@ifrworkwear.ca)**

and ask to be added to our mailing list!





## INTRODUCTION TO IFR WORKWEAR INC.

We manufacture high-quality, trusted products. Offering our customers comprehensive options for safety and comfort, through our full line of protective workwear, which includes insulated and unlined coveralls and bib overalls, parkas, fleece, vests, pants, shirts and accessories such as headwear, hard hat liners and bags for industries including oil and gas, petrochemical, mining, electrical, construction, railroad and others! All of our products are manufactured in North America and sold through distribution partners across Canada and parts of the USA.

In order to provide consistent quality, we only use proven and tested fabrics like Westex UltraSoft®, Westex® DH, Avenger, DuPont™ Nomex® IIIA, and components made in North America. 3M™ Scotchlite™ Reflective Striping is used on all the garments to meet or exceed reflective visibility requirements of industry.

In Red Deer, IFR Workwear carries a large inventory of different FR certified fabrics and eight different colours for quick delivery. All garment materials meet safety standards and comply with industry standards controlled by the CGSB (Canadian General Standards Board), the CSA (Canadian Standards Association), the NFPA (National Fire Protection Association), the ASTM (American Society for Testing and Materials International) and the OSHA (Occupational Safety and Health Administration). We provide workers with premium safety protection, increasing productivity and overall satisfaction, through excellent fit guaranteed by a large range of sizes from 34 to 70 tall, customizations, fabrics and styles.

In December of 2013, IFR Workwear moved into a new, state of the art 31,000 square foot distribution centre in the Queen's Business Park in north-west Red Deer. There, more equipment was added to the in-house embroidery and sewing department to enable us to keep the goods shipping out quickly and efficiently. We have multiple embellishment capabilities such as embroidery, heat seal, sublimation, cresting, name tags as well as the capability to do any repairs or adjustments.

We are working on developing new, innovative workwear all the time. This past year we launched a line dedicated exclusively to women, including cargo pants, a work shirt and fleece jacket. Our new Westex® DH Antistat coverall and a 3 in 1 high-vis parka were also introduced in the beginning of 2019. Our industry breakthrough product, the 2 piece "Suit-All" coverall, exclusive to IFR Workwear, provides a custom fit especially for women through a range of sizing pairing options. These coveralls are not only more comfortable to wear in the field, but also safer. Avenger by IFR was introduced in 2016. Avenger is price competitive and includes flame resistant coveralls that meet all major industry compliance made entirely from North American fabric and components. We encourage you to check our website often for new products and updates at [www.ifrworkwear.ca](http://www.ifrworkwear.ca)

In 2019, we launched our IFR BaseWear, a new line of thermal FR underwear.

***We are also excited about the continued success of our online shopping experience, accessible through the Distributor Login link at [www.ifrworkwear.ca](http://www.ifrworkwear.ca). Please email [ecommerce@ifrworkwear.ca](mailto:ecommerce@ifrworkwear.ca) for more information!***

We encourage any comments and suggestions our distributors and their customers may have that can help us develop new products or improve upon ones we already offer. We are easy to connect with through our website contact form or phone line, where you will be pleased to discover a real person answering your call! We pride ourselves on superior customer service and premium products. Safety should settle for nothing less.

**We Are One of the Top 5 FR Workwear Manufacturers in Canada!**



## ABORIGINAL COMMITMENT

IFR Workwear Inc. is an Aboriginally owned company founded in 2005 in Red Deer, Alberta by Reg Radford and Erin Buckland. Our company has an unsurpassed professional team, which makes it easy to continually serve our customers with consistent quality service and products. We own a manufacturing plant in Mexico and a distribution centre in Red Deer, Alberta which combined employ over 200 people throughout North America.

IFR Workwear Inc. is owned by Reg & Lyn Radford, who have a 40 year history of business ownership in Alberta, and Chris & Erin Buckland who have been involved with business for over 10 years. Both Lyn Radford and Erin Buckland are Metis of Cree descent. IFR Workwear Inc. also engages the services of other aboriginal people, such as the building manager, who is Metis of Cree descent, and one of IFR's lawyers, who is a Mohawk native.

### **We are a proud member of the Canadian Council for Aboriginal Business.**

Our values have the inclusion of aboriginal commitments. Some of these values are:

- A commitment to high quality products and workmanship
- A commitment to large community involvement
  - Lyn Radford was the chairman of the 2019 Canada Winter Games in Red Deer. She also previously held the Ronald McDonald House Central Alberta Capital Campaign Chair, and served on the Red Deer College Board of Governors for 6 years, amongst many others
- A commitment to inclusion, in particular with the Aboriginal community
- A commitment to education
  - IFR Workwear Inc. has had a scholarship fund through Red Deer College for Aboriginal Students since 2008

IFR Workwear Inc. distributes workwear across Canada and the US through over 250 distributors, and keeps a very large inventory consisting of many fabrics and a wide range of colours. Its 31,000 square foot distribution centre has a large embroidery department and custom sewing centre for repairs and alterations, and allows us to provide same day shipping.



IFR WORKWEAR'S  
*Women's Line*

THE  
**PERFECT FIT**  
FOR THE  
**TOUGHEST JOBS**







## Style 452 - UltraSoft® 7 oz *Suit-All* Top

## Style 453 - UltraSoft® 7 oz *Suit-All* Bottom

Featuring 2" 3M™ Scotchlite™ Reflective Trim

- 7 oz - 88% cotton, 12% high tenacity nylon from Westex®
- Engineered for flame resistance and guaranteed for the life of the garment
- 50% extended garment wear life over 100% cotton
- Soft feel of cotton comfort
- H2S monitor can attach to outside of pocket with strap and elastic fasteners
- Multi-purpose protection from electric arc, flash fire and molten ferrous metal
- Westex UltraSoft® fabric meets the requirements of:  
NFPA 2112, CGSB 155.20, NFPA 70E, CSA Z462, ASTM F1506



© Canadian Patent Design No. 148755  
US Patent Design No. D731,750



STOCK COLOURS:



STOCK SIZES:

34	36	38	40	42	44	46	48	50	52-54	56-58
34T	36T	38T	40T	42T	44T	46T	48T	50T	52T-54T	56T-58T

For Royal Blue, see styles 150 & 151 on page 47.

Regular size *Suit-All* Tops were designed to fit women or shorter men, and the tall size will fit most men. *UltraSoft*® *Suit-All* Top can also be worn with *UltraSoft*® Bib Pants - Style 422.

*Suit-All* Bottoms are measured with standard coverall sizing, not waist sizing and are only available in regular sizes, not tall.

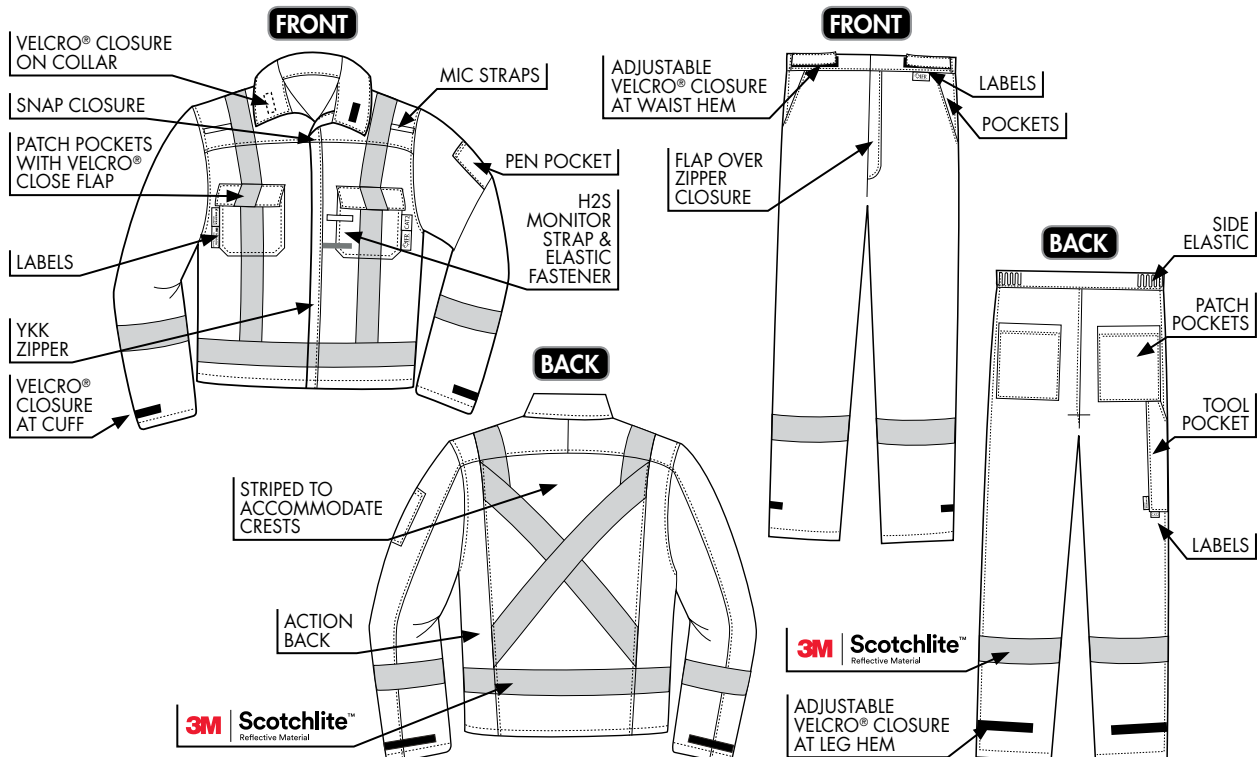

Westex UltraSoft® is a registered trademark of Westex® by Milliken® used under license by IFR Workwear Inc. 3M™ and Scotchlite™ are trademarks of 3M™ used under license by IFR Workwear Inc. in Canada.

## Style 471 - *Women's* UltraSoft® 7 oz Deluxe Segmented Striped Work Shirt

Featuring 2" 3M™ Scotchlite™ Segmented Reflective Heat Transfer Material

- 7 oz - 88% cotton, 12% high tenacity nylon from Westex®
- Engineered for flame resistance and guaranteed for the life of the garment
- 50% extended garment wear life over 100% cotton
- Soft feel of cotton comfort
- Multi-purpose protection from electric arc, flash fire and molten ferrous metal
- Westex UltraSoft® fabric meets the requirements of: NFPA 2112, CGSB 155.20, NFPA 70E, CSA Z462, ASTM F1506



STOCK COLOURS:



STOCK SIZES:

XS	S	M	L	XL	2XL
----	---	---	---	----	-----

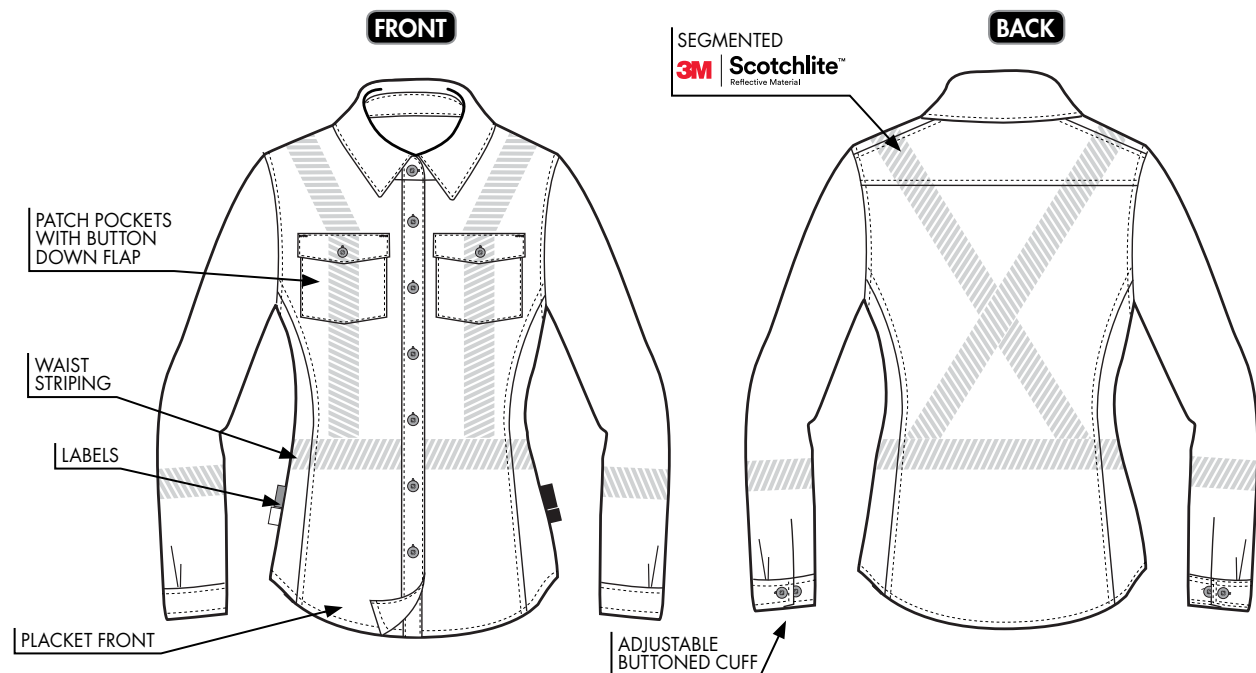

Westex UltraSoft® is a registered trademark of Westex® by Milliken® used under license by IFR Workwear Inc. 3M™ and Scotchlite™ are trademarks of 3M™ used under license by IFR Workwear Inc. in Canada.

THE TRUSTED LEADER IN QUALITY FLAME AND ARC RESISTANT WORKWEAR

www.ifrworkwear.ca | 403-347-5480 | info@ifrworkwear.ca

## Style 671 - Women's UltraSoft® 7 oz Cargo Pants

- 7 oz - 88% cotton, 12% high tenacity nylon from Westex®
- Engineered for flame resistance and guaranteed for the life of the garment
- 50% extended garment wear life over 100% cotton
- Soft feel of cotton comfort
- Multi-purpose protection from electric arc, flash fire and molten ferrous metal
- Westex UltraSoft® fabric meets the requirements of: NFPA 2112, CGSB 155.20, NFPA 70E, CSA Z462, ASTM F1506



STOCK COLOURS:



STOCK SIZES:

26	28	29	30	31	32	34	36	38
----	----	----	----	----	----	----	----	----

Unhemmed leg length to 36". Pants are measured using standard waist sizing.

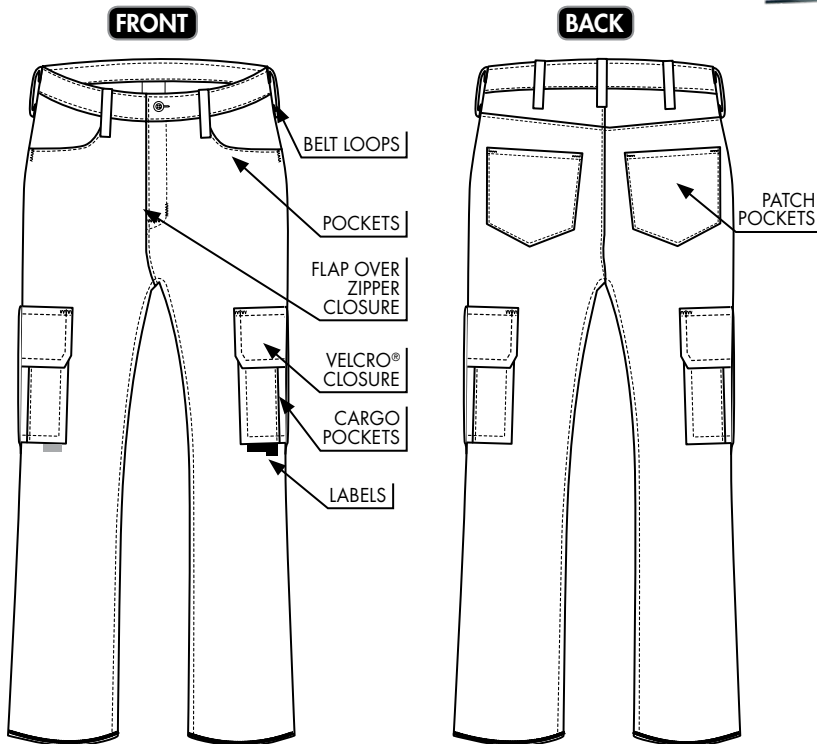

*Pairs Perfectly With:*

### Leather Belt

Style 1750 - see page 91

- Made with durable leather
- Leather is inherently flame resistant
- Fastens with FR VELCRO®, easily adjustable, tear-away style
- Absence of buckles prevents electrical arcing, static shock, snagging, and other potential workplace hazards in various industries such as electrical and oilfield
- Airport friendly

Westex UltraSoft® is a registered trademark of Westex® by Milliken® used under license by IFR Workwear Inc.



## Style 474 - Women's Segmented Striped Fleece Full Zip Jacket

Featuring 2" 3M™ Scotchlite™ Segmented Reflective Heat Transfer Material

- 14 oz - 55% modacrylic, 45% cotton
- Fabric is inherently flame resistant
- Full zipper
- Slash pockets with VISLON® zippers
- This fleece fabric meets the requirements of:  
NFPA 2112, NFPA 70E, CSA Z462



STOCK COLOURS:



STOCK SIZES:

XS	S	M	L	XL	2XL
----	---	---	---	----	-----



*Pairs Perfectly With:*

**Fleece Hood**

Style 364 - see page 83

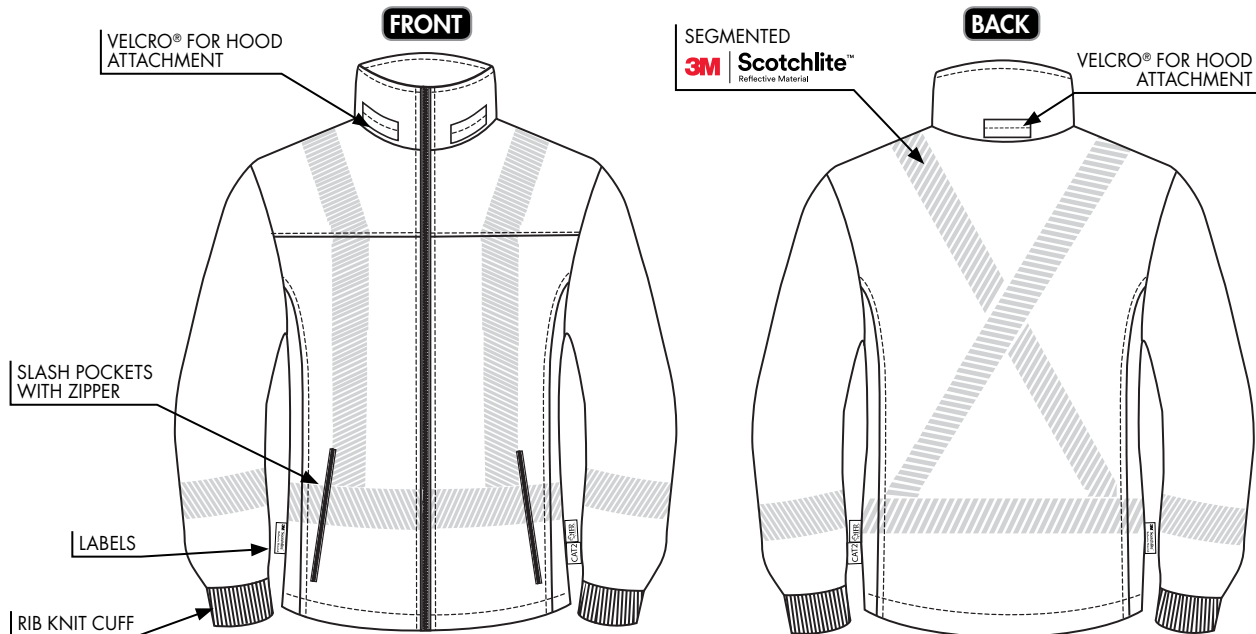

3M™ and Scotchlite™ are trademarks of 3M™ used under license by IFR Workwear Inc. in Canada.

THE TRUSTED LEADER IN QUALITY FLAME AND ARC RESISTANT WORKWEAR

www.ifrworkwear.ca | 403-347-5480 | info@ifrworkwear.ca

## Style 750 - *Women's* IFR BaseWear Top

## Style 760 - *Women's* IFR BaseWear Bottom

- 6.75 oz interlock, 45% modacrylic, 45% rayon, 10% para-aramid
- Inherently flame resistant and guaranteed for the life of the garment
- Medium weight, form fitting stretch comfort, very soft fabric with smooth flatlock seams
- Wear under FR garments for increased protection
- IFR BaseWear fabric meets the requirements of: NFPA 2112, NFPA 70E



STOCK COLOURS:



STOCK SIZES:

XS	S	M	L	XL	2XL	3XL
----	---	---	---	----	-----	-----

**NEW!**



**FRONT**

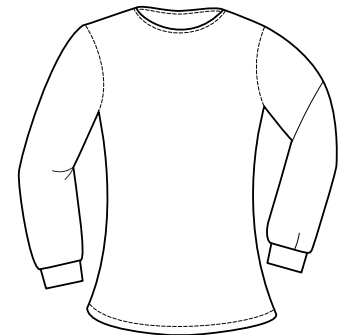

**BACK**

FLATLOCK SEAMS

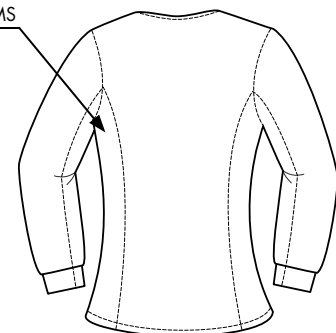

**FRONT**

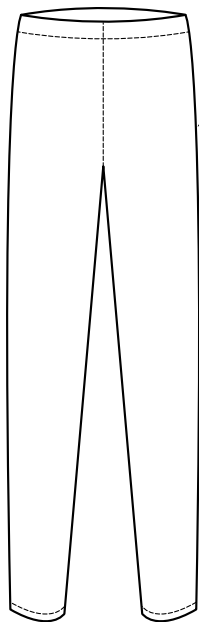

FLATLOCK SEAMS

**BACK**

ENHANCED COMFORT BACK

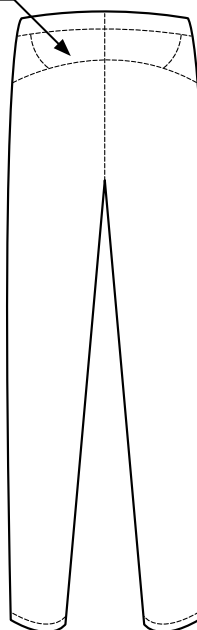



*Leading in the Flame & Arc Resistant  
Workwear Industry for 15 Years*



[www.ifrworkwear.ca](http://www.ifrworkwear.ca)

3M | Scotchlite™  
Reflective Material

AVENGER  
WORKWEAR BY IFR

WESTEX  
Miliken

DuPont™  
NOMEX® IIIA

WELD ARMOR  
BY IFR

IFR RAINWEAR

IFR BaseWear





**HIGH**  
**VERSATILITY,**

**HIGH**  
**VISIBILITY**



**HI-VIS LINE**

## Style 408 - UltraSoft® 7 oz Deluxe Coveralls

Featuring 2" 3M™ Scotchlite™ Reflective Trim

- 7 oz - 88% cotton, 12% high tenacity nylon from Westex®
- Engineered for flame resistance and guaranteed for the life of the garment
- 50% extended garment wear life over 100% cotton
- Soft feel of cotton comfort
- Breakaway zipper
- No melt, no drip VELCRO®
- H2S monitor can attach to outside of pocket with strap and elastic fasteners
- Multi-purpose protection from electric arc, flash fire and molten ferrous metal
- Westex UltraSoft® fabric meets the requirements of: NFPA 2112, CGSB 155.20, NFPA 70E, CSA Z462, ASTM F1506



STOCK COLOURS:



**ORANGE**

Part No.  
**USO408-(Size)**

STOCK SIZES:

36	38	40	42	44	46	48	50	52	54	56	58	60-62
-	38T	40T	42T	44T	46T	48T	50T	52T	54T	56T	58T	60T-62T

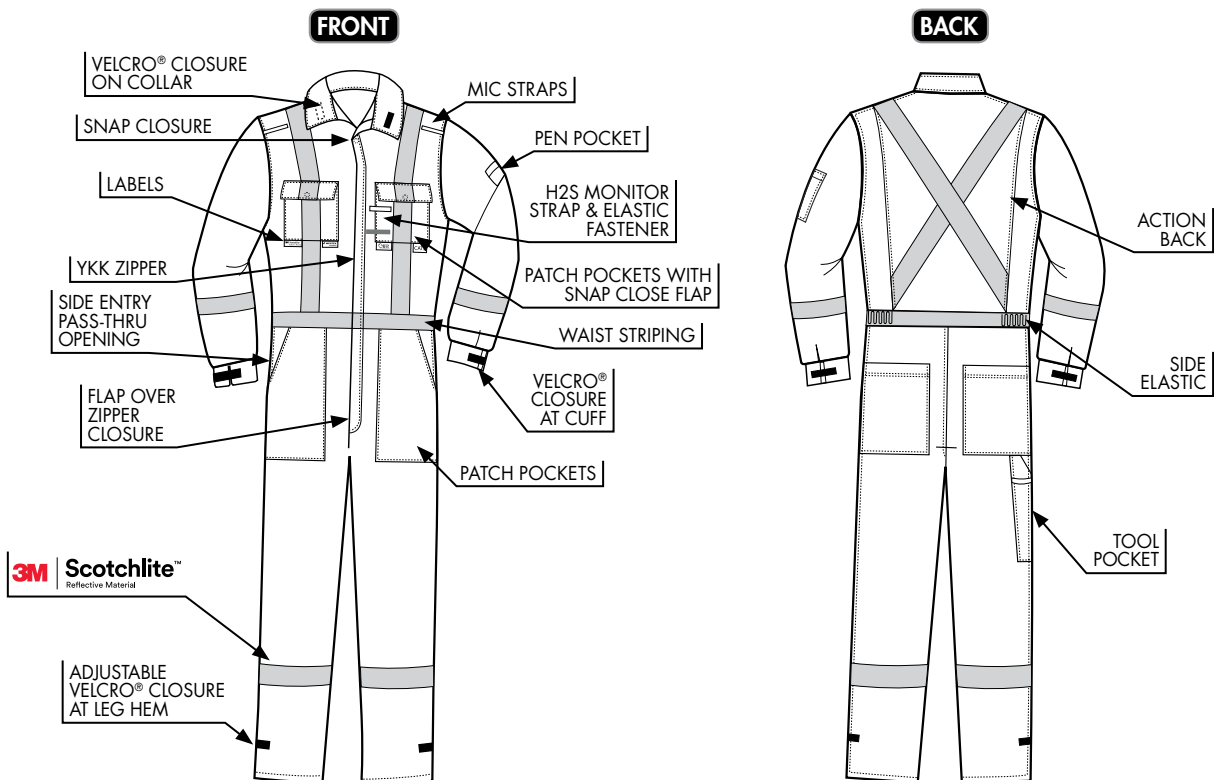

Westex UltraSoft® is a registered trademark of Westex® by Milliken® used under license by IFR Workwear Inc. 3M™ and Scotchlite™ are trademarks of 3M™ used under license by IFR Workwear Inc. in Canada.



## Style 409 - UltraSoft® 9 oz Deluxe Coveralls

Featuring 2" 3M™ Scotchlite™ Reflective Trim

- 9 oz - 88% cotton, 12% high tenacity nylon from Westex®
- Engineered for flame resistance and guaranteed for the life of the garment
- 50% extended garment wear life over 100% cotton
- Soft feel of cotton comfort
- Breakaway zipper
- No melt, no drip VELCRO®
- H2S monitor can attach to outside of pocket with strap and elastic fasteners
- Multi-purpose protection from electric arc, flash fire, molten ferrous metal and welding exposure
- Westex UltraSoft® fabric meets the requirements of: NFPA 2112, CGSB 155.20, NFPA 70E, CSA Z462, ASTM F1506



STOCK COLOURS:



**ORANGE**

Part No.

**USO409-(Size)**

STOCK SIZES:

34	36	38	40	42	44	46	48	50	52	54	56	58	60-62	64-66	68-70
-	-	38T	40T	42T	44T	46T	48T	50T	52T	54T	56T	58T	60T-62T	64T-66T	68T-70T

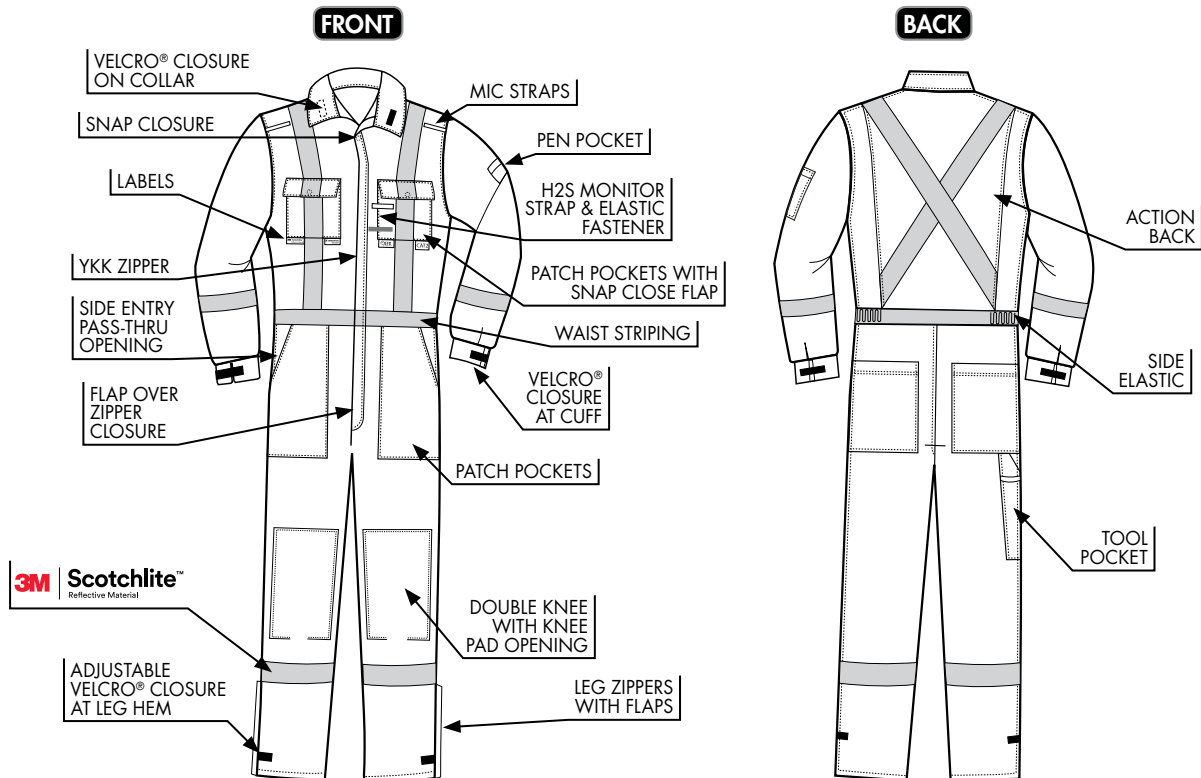

Westex UltraSoft® is a registered trademark of Westex® by Milliken® used under license by IFR Workwear Inc. 3M™ and Scotchlite™ are trademarks of 3M™ used under license by IFR Workwear Inc. in Canada.

THE TRUSTED LEADER IN QUALITY FLAME AND ARC RESISTANT WORKWEAR

www.ifrworkwear.ca | 403-347-5480 | info@ifrworkwear.ca

**Style 452 - UltraSoft® 7 oz Suit-All Top**

**Style 453 - UltraSoft® 7 oz Suit-All Bottom**

Featuring 2" 3M™ Scotchlite™ Reflective Trim

- 7 oz - 88% cotton, 12% high tenacity nylon from Westex®
- Engineered for flame resistance and guaranteed for the life of the garment
- 50% extended garment wear life over 100% cotton
- Soft feel of cotton comfort
- H2S monitor can attach to outside of pocket with strap and elastic fasteners
- Multi-purpose protection from electric arc, flash fire and molten ferrous metal
- Westex UltraSoft® fabric meets the requirements of:  
NFPA 2112, CGSB 155.20, NFPA 70E, CSA Z462, ASTM F1506



© Canadian Patent Design No. 148755  
US Patent Design No. D731,750



STOCK COLOURS:



STOCK SIZES:

34	36	38	40	42	44	46	48	50	52-54	56-58
34T	36T	38T	40T	42T	44T	46T	48T	50T	52T-54T	56T-58T

For Royal Blue, see styles 150 & 151 on page 47.

Regular size Suit-All Tops were designed to fit women or shorter men, and the tall size will fit most men. UltraSoft® Suit-All Top can also be worn with UltraSoft® Bib Pants - Style 422.

Suit-All Bottoms are measured with standard coverall sizing, not waist sizing and are only available in regular sizes, not tall.

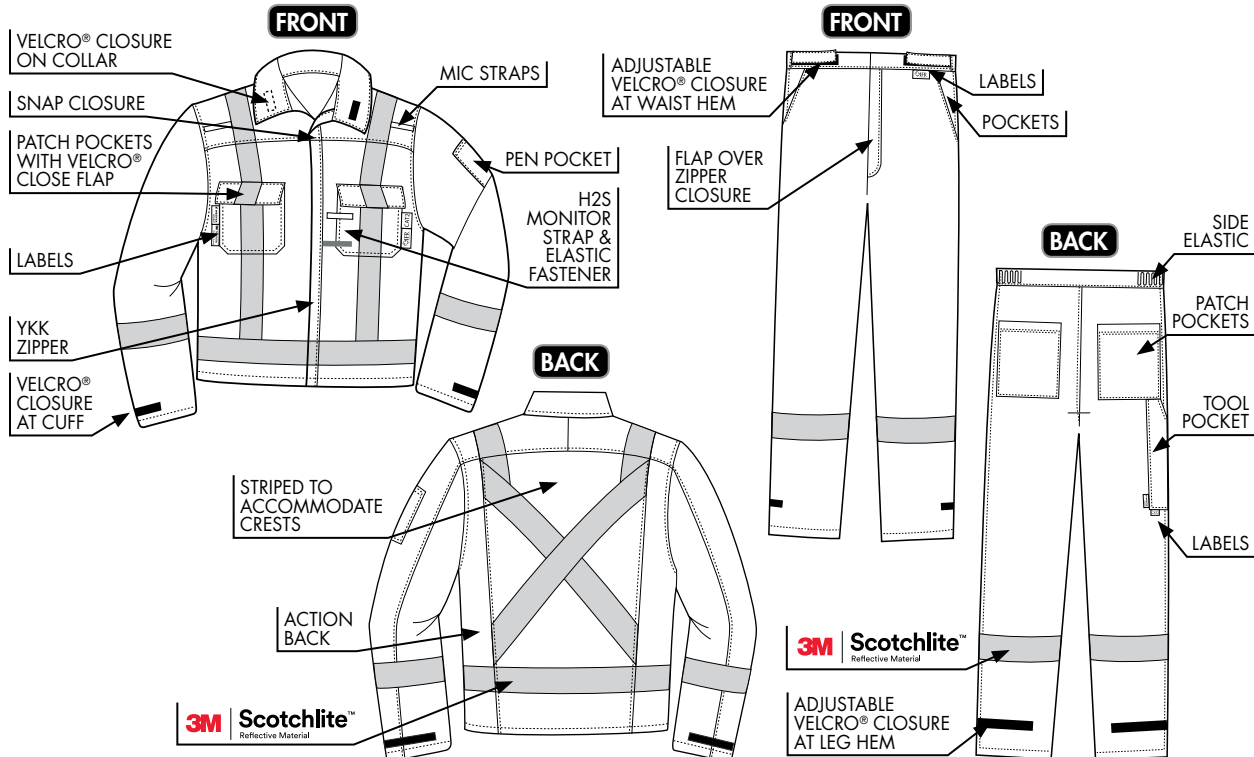

Westex UltraSoft® is a registered trademark of Westex® by Milliken® used under license by IFR Workwear Inc. 3M™ and Scotchlite™ are trademarks of 3M™ used under license by IFR Workwear Inc. in Canada.

# Style 422 - UltraSoft® 9 oz Bib Pants

Featuring 2" 3M™ Scotchlite™ Reflective Trim

- 9 oz - 88% cotton, 12% high tenacity nylon from Westex®
- Engineered for flame resistance and guaranteed for the life of the garment
- 50% extended garment wear life over 100% cotton
- Soft feel of cotton comfort
- Multi-purpose protection from electric arc, flash fire, molten ferrous metal and welding exposure
- Westex UltraSoft® fabric meets the requirements of: NFPA 2112, CGSB 155.20, NFPA 70E, CSA Z462, ASTM F1506



STOCK COLOURS:



STOCK SIZES:

S	M	L	XL	2XL	3XL	4XL
-	MT	LT	XLT	2XLT	3XLT	4XLT

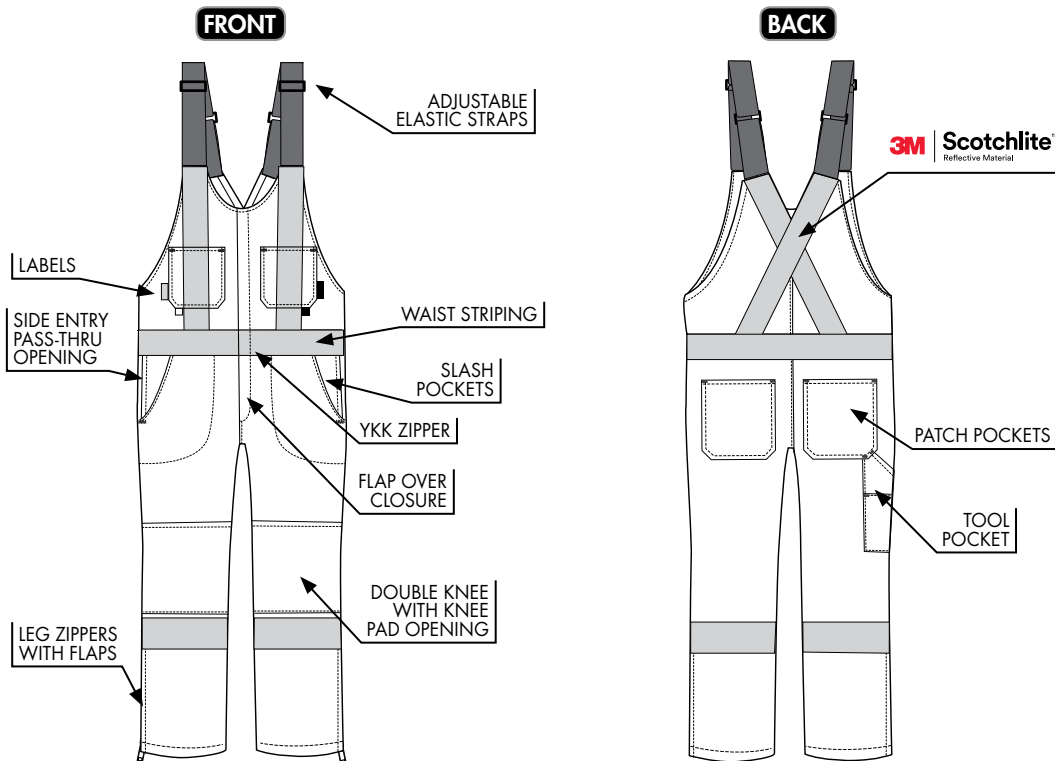

Westex UltraSoft® is a registered trademark of Westex® by Milliken® used under license by IFR Workwear Inc. 3M™ and Scotchlite™ are trademarks of 3M™ used under license by IFR Workwear Inc. in Canada.

THE TRUSTED LEADER IN QUALITY FLAME AND ARC RESISTANT WORKWEAR

www.ifrworkwear.ca | 403-347-5480 | info@ifrworkwear.ca

High Visibility Summerwear



## Style 651 - UltraSoft® 7 oz Deluxe Striped Work Shirt

Featuring 2" 3M™ Scotchlite™ Reflective Heat Transfer Material

## Style 652 - UltraSoft® 7 oz Deluxe Segmented Striped Work Shirt

Featuring 2" Segmented 3M™ Scotchlite™ Reflective Heat Transfer Material

- 7 oz - 88% cotton, 12% high tenacity nylon from Westex®
- Engineered for flame resistance and guaranteed for the life of the garment
- 50% extended garment wear life over 100% cotton
- Soft feel of cotton comfort
- Multi-purpose protection from electric arc, flash fire and molten ferrous metal
- Westex UltraSoft® fabric meets the requirements of: NFPA 2112, CGSB 155.20, NFPA 70E, CSA Z462, ASTM F1506



**NEW!**



STOCK COLOURS:



**ORANGE**  
Part No.  
**USO651-(Size) STRIPED**  
**USO652-(Size) SEGMENTED STRIPED**

STOCK SIZES:

S	M	L	XL	2XL	3XL	4XL
-	MT	LT	XLT	2XLT	3XLT	4XLT

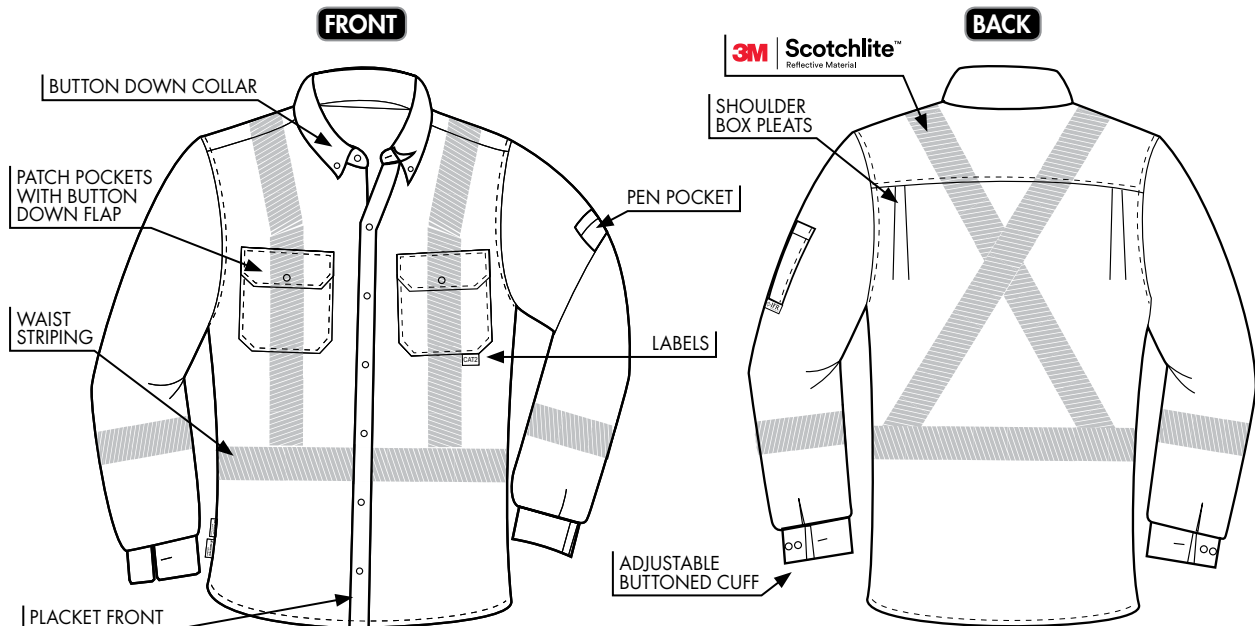

Westex UltraSoft® is a registered trademark of Westex® by Milliken® used under license by IFR Workwear Inc. 3M™ and Scotchlite™ are trademarks of 3M™ used under license by IFR Workwear Inc. in Canada.

## Style 661 - UltraSoft® 6 oz Henley Striped Long Sleeve T-Shirt

Featuring 2" 3M™ Scotchlite™ Reflective Heat Transfer Material

## Style 662 - UltraSoft® 6 oz Henley Segmented Striped Long Sleeve T-Shirt

Featuring 2" Segmented 3M™ Scotchlite™ Reflective Heat Transfer Material

- 6 oz - 88% cotton, 12% high tenacity nylon knit from Westex®
- 50% extended garment wear life over 100% cotton
- Soft feel of cotton comfort
- Multi-purpose protection from electric arc and molten ferrous metal
- Westex UltraSoft® knit fabric meets the requirements of: ASTM F1506, NFPA 70E, CSA Z462



STOCK COLOURS:

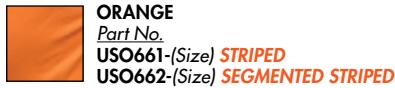

STOCK SIZES:

S	M	L	XL	2XL	3XL	4XL
-	MT	LT	XLT	2XLT	3XLT	4XLT

**NEW!**



**FRONT**

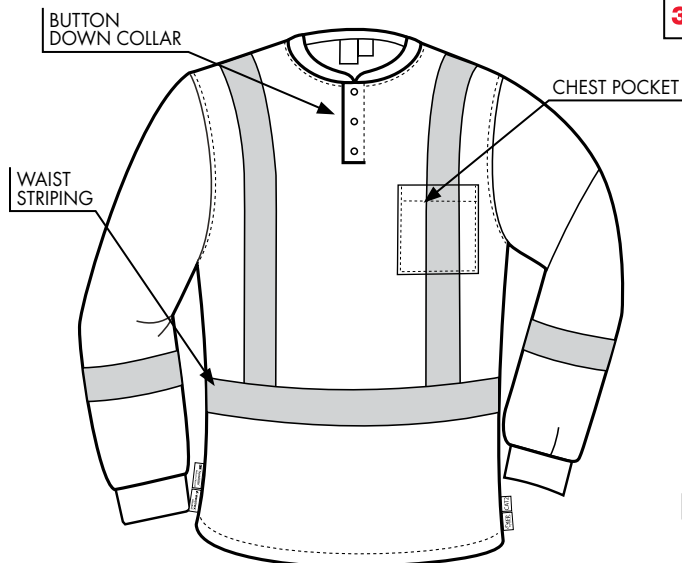

**BACK**

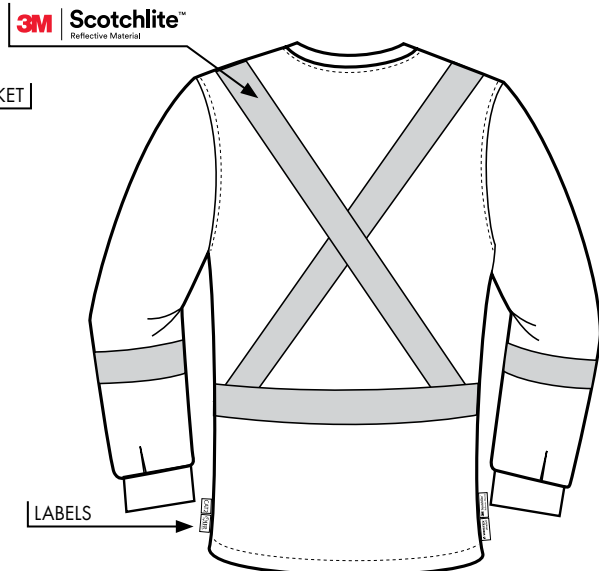

Westex UltraSoft® is a registered trademark of Westex® by Milliken® used under license by IFR Workwear Inc. 3M™ and Scotchlite™ are trademarks of 3M™ used under license by IFR Workwear Inc. in Canada.

THE TRUSTED LEADER IN QUALITY FLAME AND ARC RESISTANT WORKWEAR

www.ifrworkwear.ca | 403-347-5480 | info@ifrworkwear.ca

## Style 327 - Striped Fleece Pullover

Featuring 2" 3M™ Scotchlite™ Reflective Trim

- 14 oz - 55% modacrylic, 45% cotton
- Fabric is inherently flame resistant
- 8" VISLON® zipper
- Kangaroo pocket
- This fleece fabric meets the requirements of: NFPA 2112, NFPA 70E, CSA Z462



STOCK COLOURS:



**ORANGE**

*Part No.*

**OSO327-(Size)**

STOCK SIZES:

S	M	L	XL	2XL	3XL	4XL
-	MT	LT	XLT	2XLT	3XLT	4XLT



*Pairs Perfectly With:*

**Fleece Hood**

Style 364 - see page 83

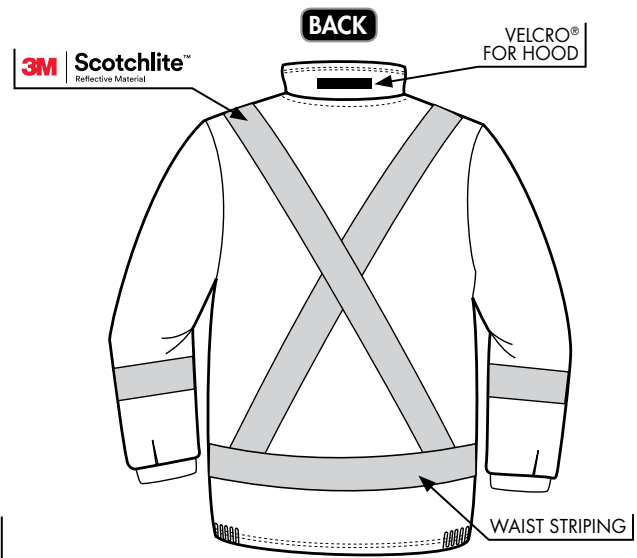
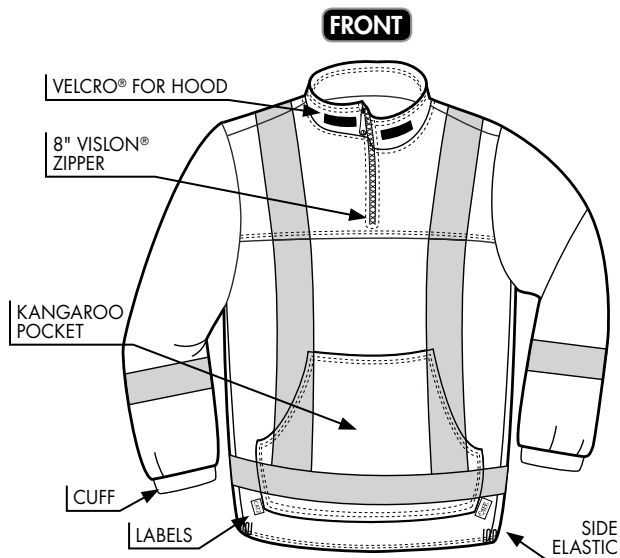

3M™ and Scotchlite™ are trademarks of 3M™ used under license by IFR Workwear Inc. in Canada.

## Style 329 - Segmented Striped Fleece Full Zip Jacket

Featuring 2" Segmented 3M™ Scotchlite™ Reflective Trim

- 14 oz - 55% modacrylic, 45% cotton
- Fabric is inherently flame resistant
- Full zip fleece
- Slash pockets
- Loops to attach 413 jacket
- This fleece fabric meets the requirements of:  
NFPA 2112, NFPA 70E, CSA Z462



**NEW!**



STOCK COLOURS:



**ORANGE**

Part No.  
**OSO329-(Size)**

STOCK SIZES:

S	M	L	XL	2XL	3XL
-	-	LT	XLT	2XLT	3XLT



### MAKE IT A 3 IN 1

Add the UltraSoft® 7 oz Shell Jacket (Style 413) on page 21 to make the 3 in 1 Jacket!

*Pairs Perfectly With:*

**Fleece Hood**

Style 364 - see page 83

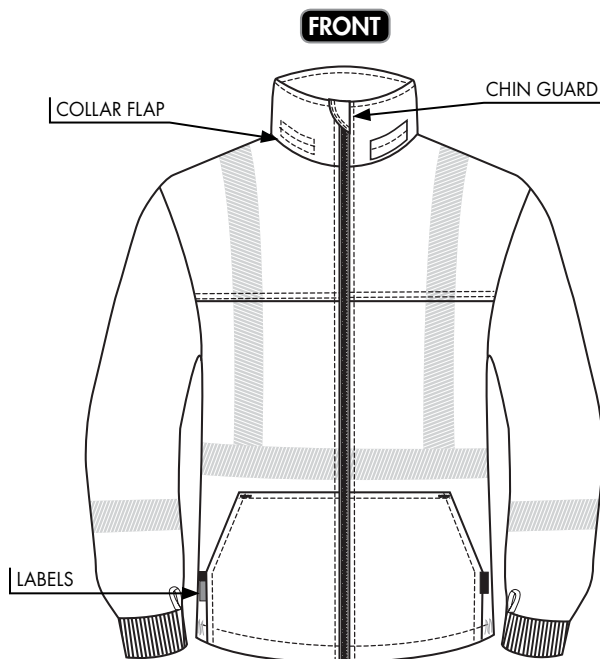

3M™ and Scotchlite™ are trademarks of 3M™ used under license by IFR Workwear Inc. in Canada.

THE TRUSTED LEADER IN QUALITY FLAME AND ARC RESISTANT WORKWEAR

www.ifrworkwear.ca | 403-347-5480 | info@ifrworkwear.ca



## Style 413 - UltraSoft® 7 oz Shell Jacket

Featuring 2" 3M™ Scotchlite™ Reflective Trim

- 7 oz - 88% cotton, 12% high tenacity nylon outer shell from Westex®
- 7 oz - 88% cotton, 12% high tenacity nylon lining from Westex®
- Slanted fleece lined hand pockets
- Inner chest pocket
- H2S monitor can attach to outside of pocket with strap and elastic fasteners
- Multi-purpose protection from electric arc and molten ferrous metal
- Zip-in orange fleece style 329, navy fleece style 324 or orange freezer jacket style 417 to make a 3 in 1
- Westex UltraSoft® fabric meets the requirements of: NFPA 2112, CGSB 155.20, NFPA 70E, CSA Z462, ASTM F1506



STOCK COLOURS:



STOCK SIZES:

S	M	L	XL	2XL	3XL
-	-	LT	XLT	2XLT	3XLT



### MAKE IT A 3 IN 1

Add a Striped Fleece Jacket (Style 324 or 329) on pages 80 and 20 or a Quilted Freezer Jacket (Style 417) on page 22 to make the 3 in 1 Jacket!

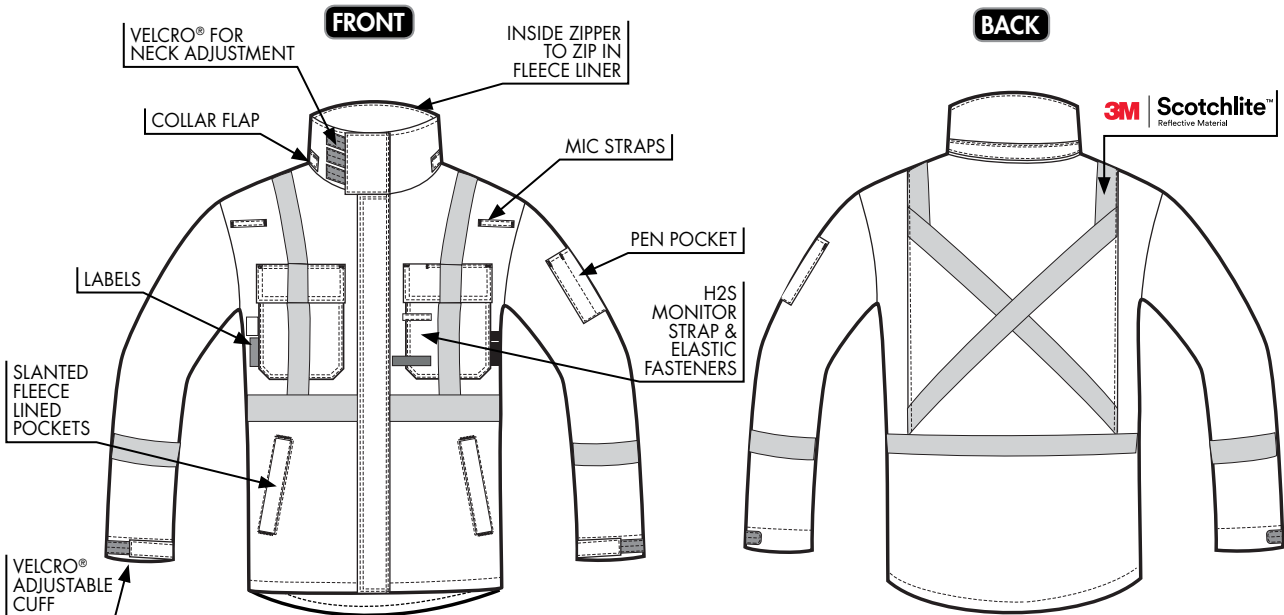

Westex UltraSoft® is a registered trademark of Westex® by Milliken® used under license by IFR Workwear Inc. 3M™ and Scotchlite™ are trademarks of 3M™ used under license by IFR Workwear Inc. in Canada.

## Style 417 - UltraSoft® Quilted Freezer Jacket

Featuring 2" 3M™ Scotchlite™ Reflective Trim

**SHELL:**

- 7 oz - 88% cotton, 12% high tenacity nylon from Westex®
- Engineered for flame resistance and guaranteed for the life of the garment
- 50% extended garment wear life over 100% cotton
- Multi-purpose protection from electric arc and molten ferrous metal
- Westex UltraSoft® fabric meets the requirements of: NFPA 2112, CGSB 155.20, NFPA 70E, CSA Z462, ASTM F1506

**INSULATION:**

- 4 oz modacrylic insulation (flame resistant)

**LINING:**

- 6.5 oz - 88% cotton, 12% high tenacity nylon from Westex®



**NEW!**

STOCK COLOURS:



STOCK SIZES:

S	M	L	XL	2XL	3XL
-	MT	LT	XLT	2XLT	3XLT



**MAKE IT A 3 IN 1**

Add the UltraSoft® 7 oz Shell Jacket (Style 413) on page 21 to make the 3 in 1 Jacket!

**FRONT**

**BACK**

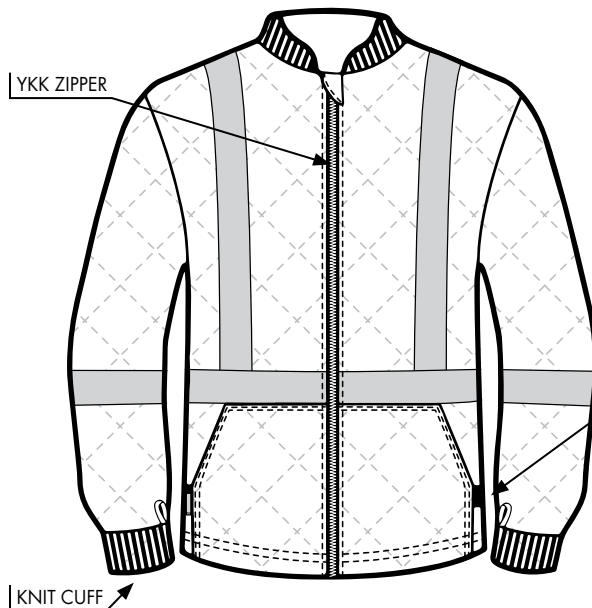

Westex UltraSoft® is a registered trademark of Westex® by Milliken® used under license by IFR Workwear Inc. 3M™ and Scotchlite™ are trademarks of 3M™ used under license by IFR Workwear Inc. in Canada.

## Style 513 - 3 in 1 Parka

Featuring 2" 3M™ Scotchlite™ Reflective Trim

- 3 in 1 jacket includes USO413, UPO265, OSO329 and OPO364
- Shell and fleece can be worn separately
- Comes with a hood for both the shell and fleece
- Multi-purpose protection from electric arc and molten ferrous metal

### SHELL & SHELL LINING:

- 7 oz - 88% cotton, 12% high tenacity nylon from Westex®
- H2S monitor can attach to outside of pocket with strap and elastic fasteners
- Slanted fleece lined hand pockets
- Inner chest pocket
- Westex UltraSoft® fabric meets the requirements of: NFPA 2112, CGSB 155.20, NFPA 70E, CSA Z462, ASTM F1506

### FLEECE:

- 55% modacrylic, 45% cotton
- Full zip fleece with slash pockets
- This fleece fabric meets the requirements of: NFPA 2112, NFPA 70E, CSA Z462



Shell Only



Style 413  
UltraSoft®  
7 oz Shell  
Jacket

Fleece Only



Style 329  
Segmented  
Striped Fleece  
Full Zip Jacket



STOCK COLOURS:



STOCK SIZES:

S	M	L	XL	2XL	3XL
-	-	LT	XLT	2XLT	3XLT

### INCLUDES:

Insulated Parka Hood

Style 265 - see page 56

Fleece Hood

Style 364 - see page 83

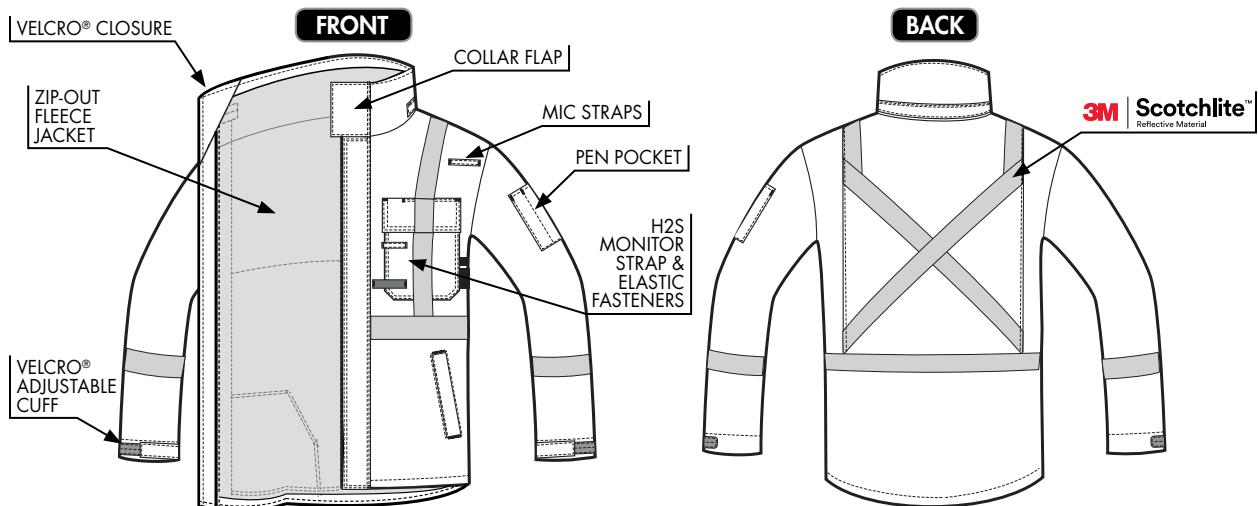

3M™ and Scotchlite™ are trademarks of 3M™ used under license by IFR Workwear Inc. in Canada.



# Style 515 - UltraSoft® 9 oz Insulated Parka

# Style 525 - UltraSoft® 9 oz Insulated Bib Pants

Featuring 2" 3M™ Scotchlite™ Reflective Trim

### SHELL:

- 9 oz - 88% cotton, 12% high tenacity nylon from Westex®
- Engineered for flame resistance and guaranteed for the life of the garment
- 50% extended garment wear life over 100% cotton
- Flame resistant fleece lined hand pockets
- Multi-purpose protection from electric arc, flash fire, molten ferrous metal and welding exposure
- Westex UltraSoft® fabric meets the requirements of: NFPA 2112, CGSB 155.20, NFPA 70E, CSA Z462, ASTM F1506

### INSULATION PACKAGE - 12 OZ QUILTED:

- Wind and vapour barrier
- Modacrylic insulation (flame resistant)
- 88% cotton, 12% high tenacity nylon lining



STOCK COLOURS:



STOCK SIZES:

S	M	L	XL	2XL	3XL	4XL
-	MT	LT	XLT	2XLT	3XLT	4XLT

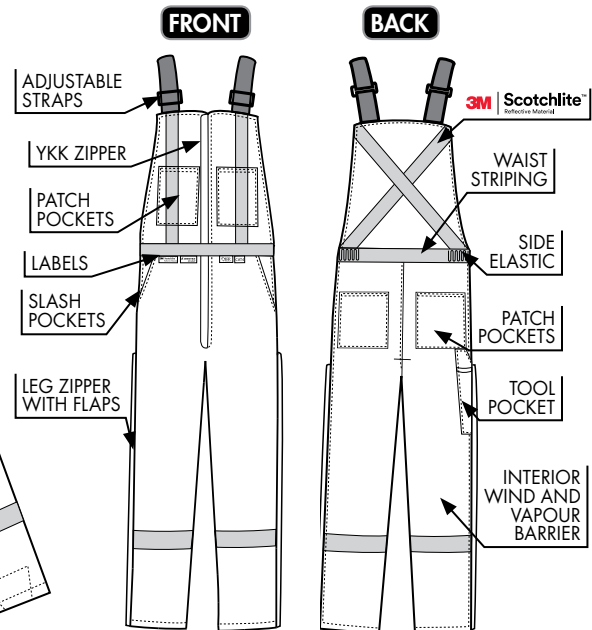
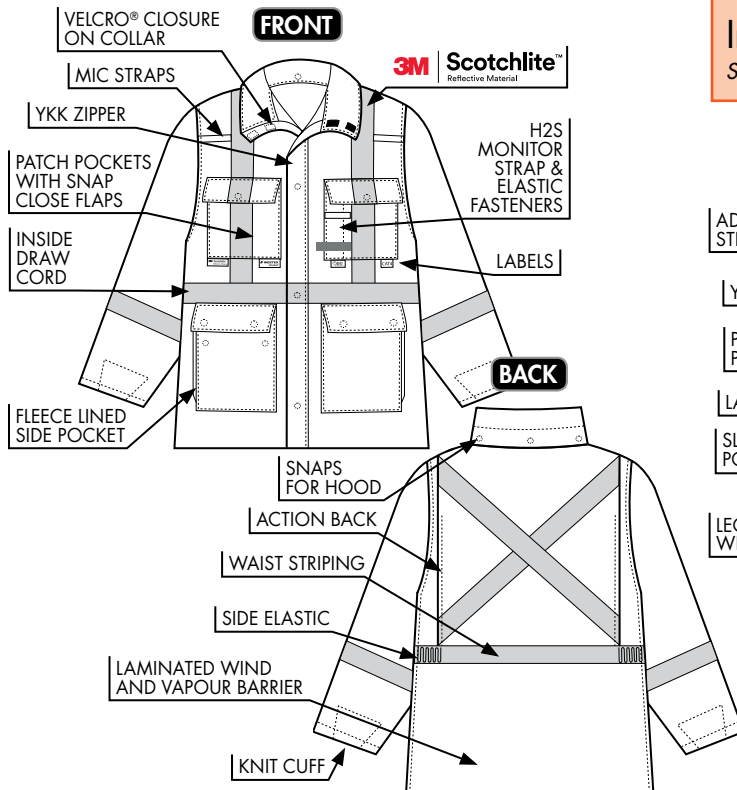

Pairs Perfectly With:  
Insulated Parka Hood  
Style 265 - see page 56

Westex UltraSoft® is a registered trademark of Westex® by Milliken® used under license by IFR Workwear Inc. 3M™ and Scotchlite™ are trademarks of 3M™ used under license by IFR Workwear Inc. in Canada.

THE TRUSTED LEADER IN QUALITY FLAME AND ARC RESISTANT WORKWEAR

www.ifrworkwear.ca | 403-347-5480 | info@ifrworkwear.ca

High Visibility Winterwear

## Style 1130 - UltraSoft® 7 oz FR Surveyor Vest

4" Trim Featuring 2" 3M™ Scotchlite™ Reflective Material

Designed with a multitude of pockets that are situated where you need them; including three inside pockets with VELCRO® closures, cell phone/GPS pockets, pen and tool pockets, a reinforced side map pocket with zipper closure, and grommets installed in the two lower front pockets for convenience to pull ribbon/tape through.

Specially designed for surveying, but suitable for anywhere flame resistance and high visibility is needed, including, but not limited to: oil and gas, utilities, railroad, construction/traffic.

- 7 oz - 88% cotton, 12% high tenacity nylon from Westex®
- 4" reflective tape for environments that require 4" reflective specifications
- Engineered for flame resistance and guaranteed for the life of the garment
- 50% extended garment wear life over 100% cotton
- Soft feel of cotton comfort
- Multi-purpose protection from electric arc, flash fire and molten ferrous metal
- Westex UltraSoft® fabric meets the requirements of: NFPA 2112, CGSB 155.20, NFPA 70E, CSA Z462, ASTM F1506



STOCK COLOURS:



STOCK SIZES:

S	M	L	XL	2XL	3XL	4XL
---	---	---	----	-----	-----	-----



Two Inner Cell Phone/  
Accessory Pockets with  
VELCRO® Loop Closures



Large Inner Pockets  
with VELCRO® Closures



Reinforced  
Map Pocket with  
Zipper Closure

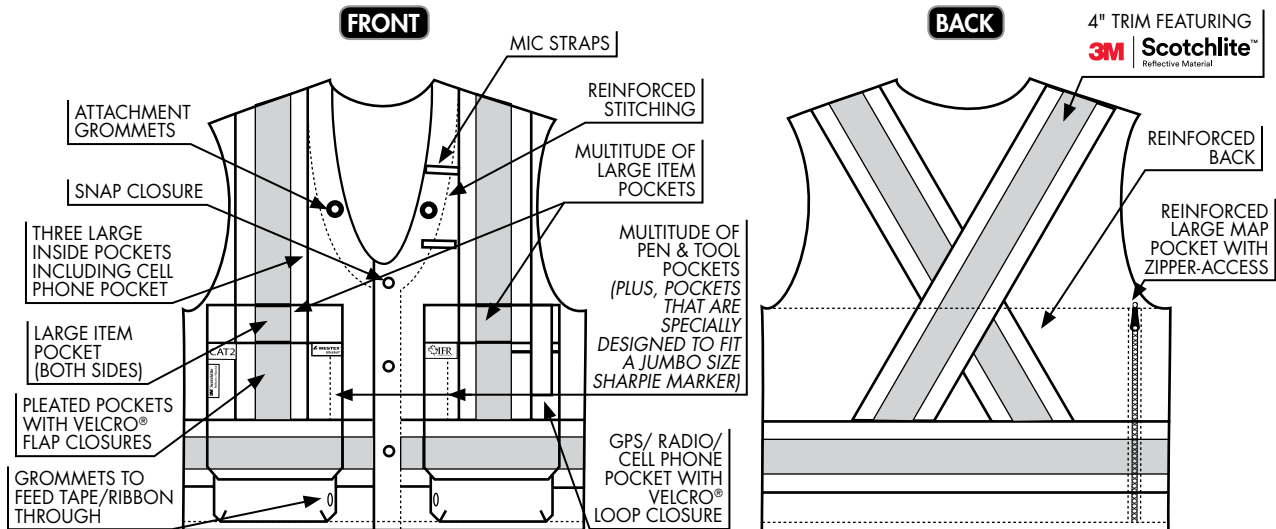

Westex UltraSoft® is a registered trademark of Westex® by Milliken® used under license by IFR Workwear Inc. 3M™ and Scotchlite™ are trademarks of 3M™ used under license by IFR Workwear Inc. in Canada.

# Style 1715 - UltraSoft® 7 oz FR Yard Vest

Featuring 2" 3M™ Scotchlite™ Reflective Heat Transfer Industrial Material

- 7 oz - 88% cotton, 12% high tenacity nylon from Westex®
- Engineered for flame resistance and guaranteed for the life of the garment
- 50% extended garment wear life over 100% cotton
- Soft feel of cotton comfort
- No melt, no drip VELCRO®
- Multi-purpose protection from electric arc, flash fire and molten ferrous metal
- Westex UltraSoft® fabric meets the requirements of: NFPA 2112, CGSB 155.20, NFPA 70E, CSA Z462, ASTM F1506



STOCK COLOURS:



STOCK SIZES:

S	M	L	XL	2XL	3XL	4XL
---	---	---	----	-----	-----	-----

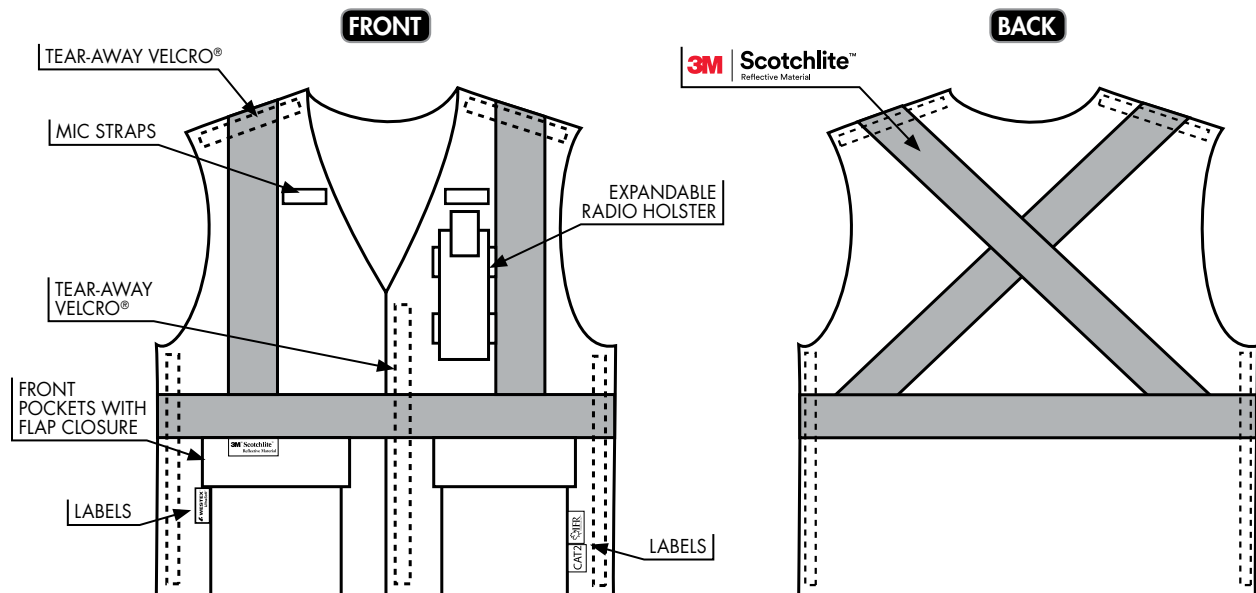

Westex UltraSoft® is a registered trademark of Westex® by Milliken® used under license by IFR Workwear Inc. 3M™ and Scotchlite™ are trademarks of 3M™ used under license by IFR Workwear Inc. in Canada.

THE TRUSTED LEADER IN QUALITY FLAME AND ARC RESISTANT WORKWEAR

www.ifrworkwear.ca | 403-347-5480 | info@ifrworkwear.ca



## Style 1715 - Mesh Yard Vest

Featuring 2" 3M™ Scotchlite™ Reflective Trim

- 5-Point tear-away system that allows the vest to "tear-away" at 5 points in case of emergencies
- Made with "Hi-Viz" 100% polyester mesh
- Expandable radio holster



**5 Point  
Tear-Away**



STOCK COLOURS:



**ORANGE**

Part No.  
1715-2130-(Size)



**LIME**

Part No.  
1715-7130-(Size)

STOCK SIZES:

S	M	L	XL	2XL	3XL	4XL
---	---	---	----	-----	-----	-----

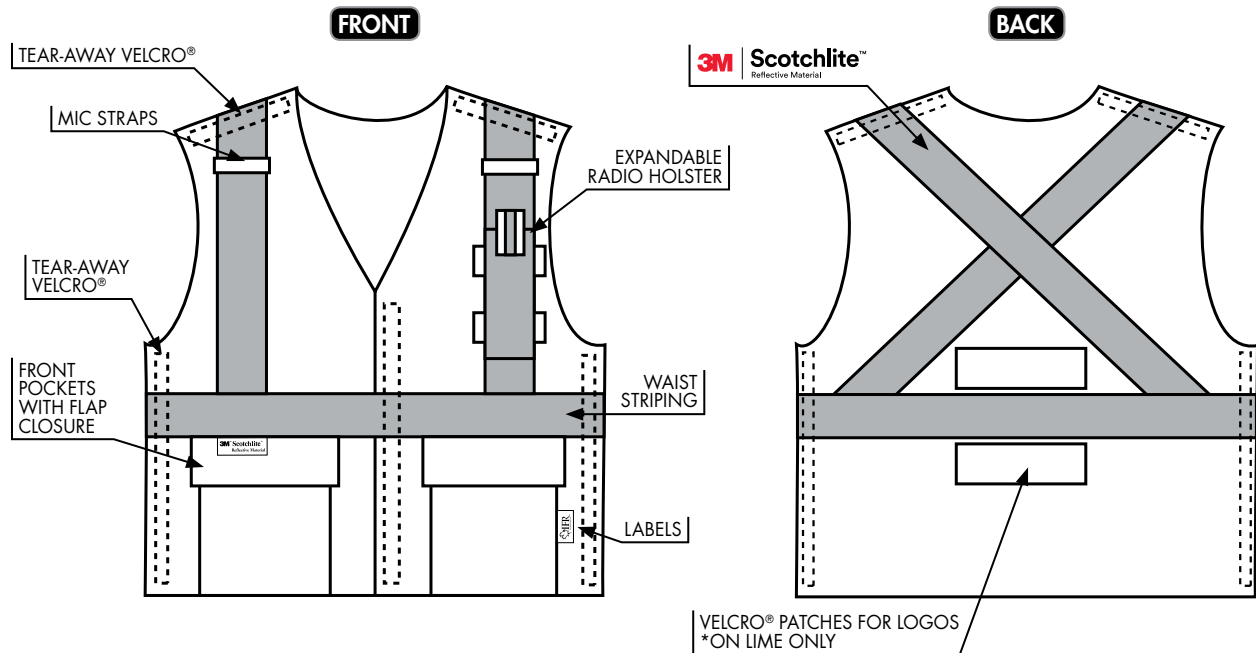

3M™ and Scotchlite™ are trademarks of 3M™ used under license by IFR Workwear Inc. in Canada.

# Style 7215SJ - **FLEXARC** 10 oz Polyurethane/FR Cotton Rain Jacket

# Style 7215BT - **FLEXARC** 10 oz Polyurethane/FR Cotton Bib Pants

Featuring 2" 3M™ Scotchlite™ Reflective Trim

- 10 oz flexible polyurethane on FR cotton
- Multi-purpose protection from electric arc and flash fire
- VISLON® zipper front with storm VELCRO® closure
- Detachable hood with drawstring
- "D" ring access port
- Inner left chest cell phone pocket
- Heat sealed seams
- Ideal for electrical utilities, gas companies, electrical maintenance, electrical switching, utility storm/foul weather restoration, meter and pipeline servicing/maintenance
- IFR Rainwear fabrics meet the requirements of:  
ASTM F1891, ASTM F2733

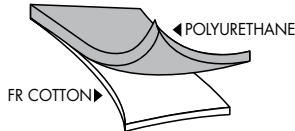

STOCK COLOURS:

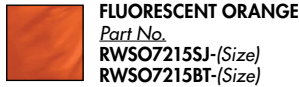

STOCK SIZES:

S	M	L	XL	2XL	3XL	4XL
-	-	LT	XLT	2XLT	-	-



### HOOD

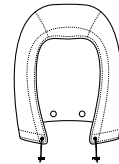

\*One hood is included with each rain jacket. EXTRA hoods can be purchased separately.  
Part No: RWSO7215HO



when rain jacket and bib pants are combined

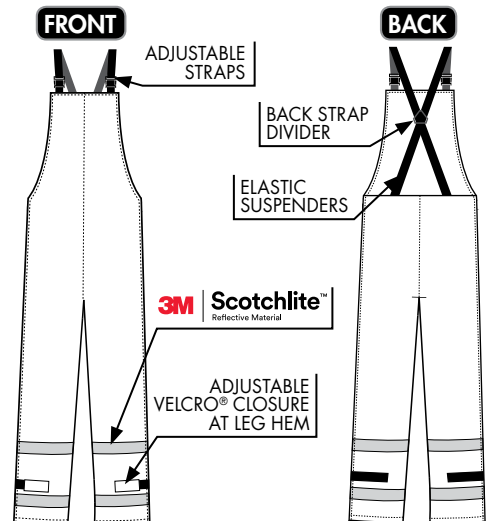
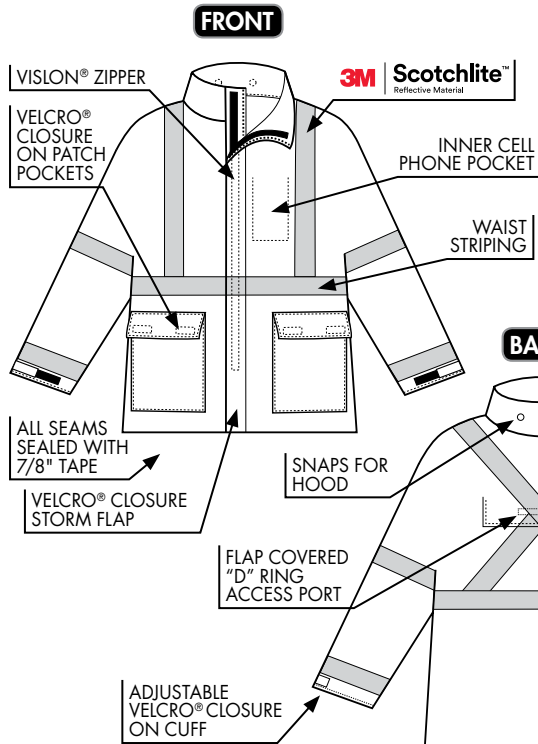

3M™ and Scotchlite™ are trademarks of 3M™ used under license by IFR Workwear Inc. in Canada.

THE TRUSTED LEADER IN QUALITY FLAME AND ARC RESISTANT WORKWEAR



**Scotchlite™**  
Reflective Material

# Create a more visible world

3M™ Scotchlite™ Reflective Material



## Understanding the way we see and what gets our attention

Many factors come into play in helping make people visible to drivers.

After the age of 20, a person's illumination needs **double every 13 years.**

**Only 2° of our vision** is in high definition and colour.

2X



There are more **drivers aged 65+** on the road and in work zones than ever before.



Our brains are wired to recognize **human form and motion.**

Drivers moving only 48 km/h may travel more than 152 m in the time it takes to recognize and properly manoeuvre their car. At 96 km/h that distance **more than doubles.**



A pedestrian wearing a white shirt may not be visible to drivers until they are **within 91 m.**





# Distance required for drivers to respond to an object on the roadway\* – You only have a few seconds.

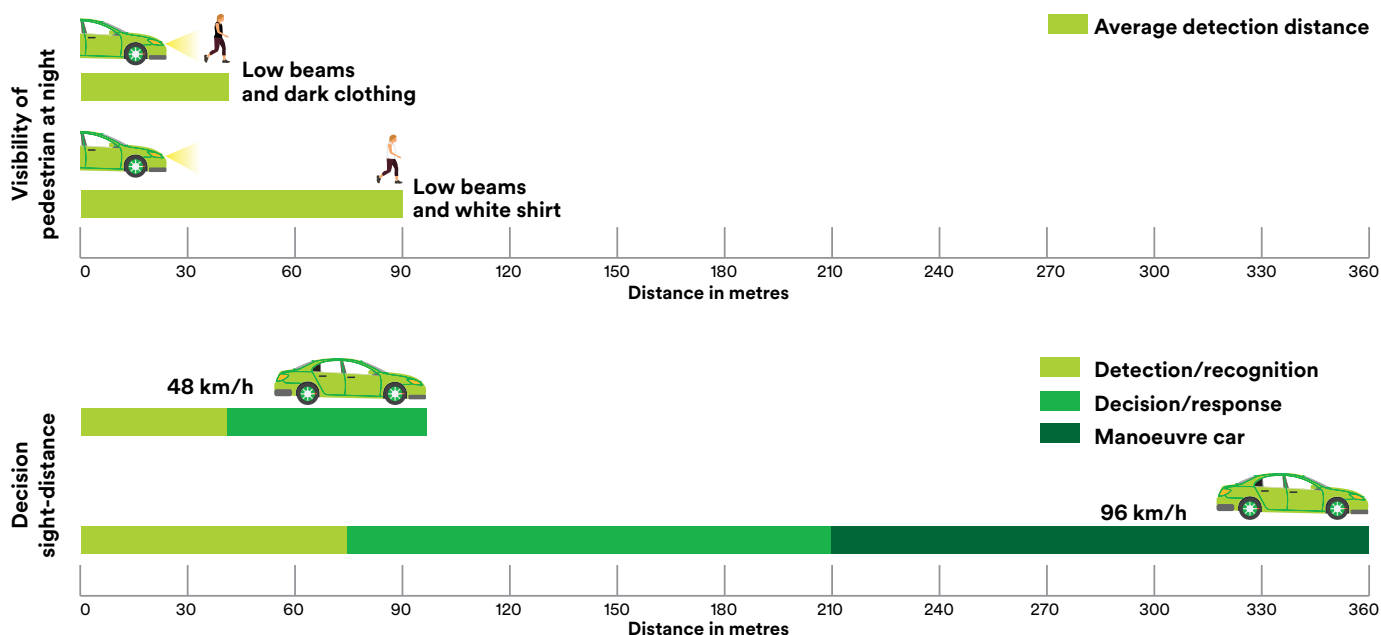

## It's important to know how to get noticed



### 1. Wear apparel that incorporates reflective material

Amount and location of reflective material matters.



### 4. Move it

Reflective material should be applied to areas of high movement (like wrists, ankles and feet) to catch drivers' eyes.



### 7. Don't assume!

Just because you can see a car's headlights does not mean the driver can see you. Always be aware of your surroundings.



### 2. Reflect from all directions

Reflective material should be visible on the front, back and both sides of the garment.



### 5. Shine brightly

Not all reflective material works the same. Choose 3M™ Scotchlite™ Reflective Material and be confident in your reflective trim's performance.



### 3. More is better

Wide reflective striping that is strategically placed will stand out more than a small reflective logo.



### 6. Accidents happen in daytime too

During daytime, and in the low light hours of dawn and dusk, it is especially important to wear fluorescent material.



Curious if one of our 3M™ Scotchlite™ Reflective Materials will work for you?  
[3M.ca/Scotchlite](http://3M.ca/Scotchlite)

**AVENGER**  
WORKWEAR BY  IFR

**IFR Quality**

**Price Competitive**

**Meets all Major  
Certifications:**

NFPA 2112

CGSB 155.20

ASTM 1506

NFPA 70E

CSA Z462

CSA Class 1 Level FR







# Style 3108 - AVENGER 7 oz Coveralls

Trim Featuring 3M™ Scotchlite™ Reflective Material

- 7 oz - FR 88% cotton, 12% nylon twill weave, preshrunk fabric
- Flame resistant and guaranteed for the life of the garment
- 50% more life than 100% cotton
- Multi-purpose protection from electric arc and flash fire
- Breakaway zipper
- NAFTA - made with North American fabric and components
- Price competitive
- Lowered X striping on back to allow room for company logo or hooded undergarment\*\*
- Avenger fabric is UL certified and meets the requirements of: NFPA 2112, CGSB 155.20, NFPA 70E, CSA Z462, ASTM F1506



STOCK COLOURS:

	<b>ROYAL BLUE</b> Part No. ASB3108-(Size)		<b>RED</b> Part No. ASR3108-(Size)
	<b>BLACK</b> Part No. ASBK3108-(Size)		<b>NAVY</b> Part No. ASN3108-(Size)
			<b>GREY</b> Part No. ASGY3108-(Size)

STOCK SIZES:

34*	36*	38	40	42	44	46	48	50	52	54	56	58	60-62*
-	36T*	38T	40T	42T	44T	46T	48T	50T	52T	54T	56T	58T	60-62T*

\*All sizes not available in all colours, please call for availability.

\*\*Hood provision is added to the new CSA Z96-15 standard.

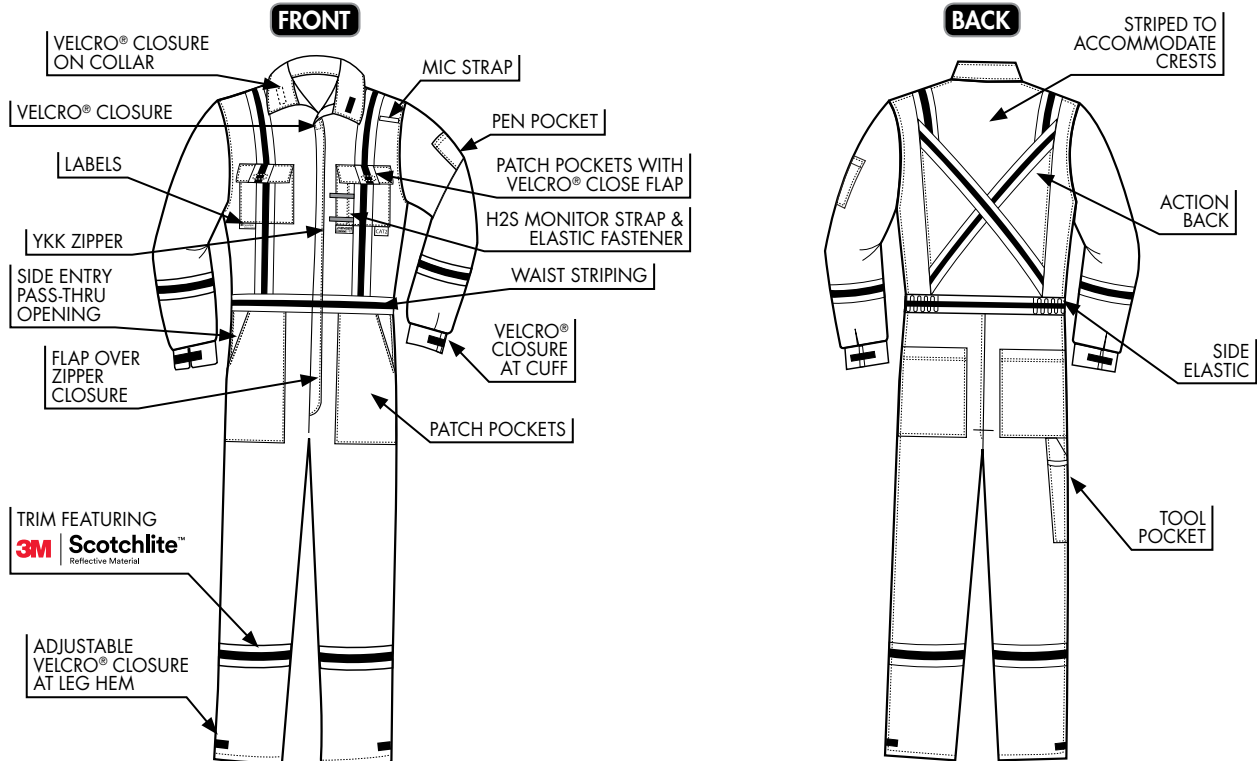

3M™ and Scotchlite™ are trademarks of 3M™ used under license by IFR Workwear Inc. in Canada.

## Style 3122 - **AVENGER** 12 oz Duck Bib Pants

Trim Featuring 3M™ Scotchlite™ Reflective Material

- 12 oz - FR 100% cotton, preshrunk fabric
- Flame resistant and guaranteed for the life of the garment
- Multi-purpose protection from electric arc and flash fire
- NAFTA - made with North American fabric and components
- Price competitive
- Avenger fabric is UL certified and meets the requirements of: NFPA 2112, CGSB 155.20, NFPA 70E, CSA Z462, ASTM F1506



STOCK COLOURS:



STOCK SIZES:

S	M	L	XL	2XL	3XL	4XL
-	MT	LT	XLT	2XLT	3XLT	4XLT



**FRONT**

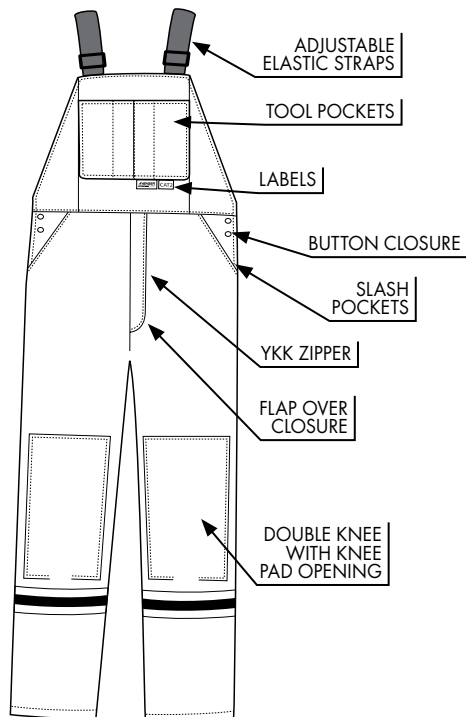

**BACK**

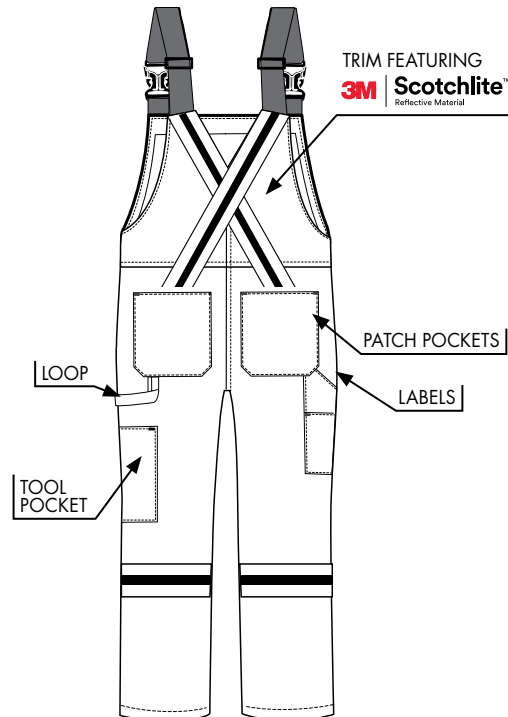

3M™ and Scotchlite™ are trademarks of 3M™ used under license by IFR Workwear Inc. in Canada.

THE TRUSTED LEADER IN QUALITY FLAME AND ARC RESISTANT WORKWEAR

www.ifrworkwear.ca | 403-347-5480 | info@ifrworkwear.ca

## Style 3610 - AVENGER 12 oz Duck Work Pants

- 12 oz - FR 100% cotton, preshrunk fabric
- Flame resistant and guaranteed for the life of the garment
- Multi-purpose protection from electric arc and flash fire
- NAFTA - made with North American fabric and components
- Price competitive
- Avenger fabric is UL certified and meets the requirements of: NFPA 2112, CGSB 155.20, NFPA 70E, CSA Z462, ASTM F1506



STOCK COLOURS:



STOCK SIZES:

28	30	32	34	36	38	40	42	44	46	48
----	----	----	----	----	----	----	----	----	----	----

36" unhemmed leg length. Pants are measured using standard waist sizing.

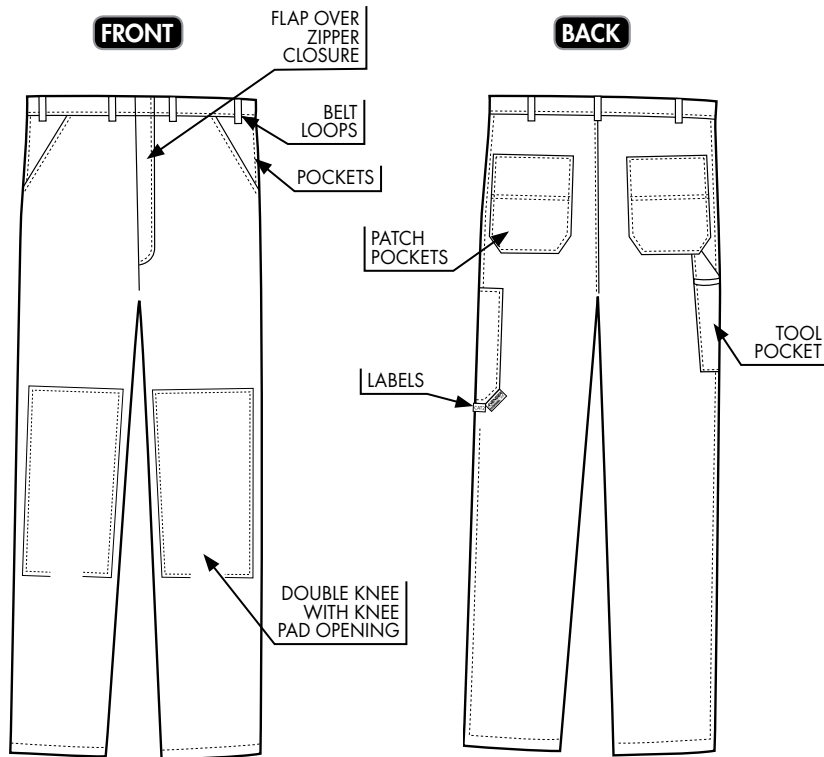

*Pairs Perfectly With:*

### Leather Belt

Style 1750 - see page 91

- Made with durable leather
- Leather is inherently flame resistant
- Fastens with FR VELCRO®, easily adjustable, tear-away style
- Absence of buckles prevents electrical arcing, static shock, snagging, and other potential workplace hazards in various industries such as electrical and oilfield
- Airport friendly



## Style 1250 - AVENGER 7 oz FR Surveyor Vest

Trim Featuring 3M™ Scotchlite™ Reflective Material

Style 1250 gives you everything you need at your fingertips. Made from 7 oz Avenger fabric, this material is flame resistant and comfortable to wear. All trim including VELCRO® and webbing are also flame resistant.

A multitude of pockets are situated where you need them, including four inside pockets.

- 7 oz - FR 88% cotton, 12% nylon twill weave, preshrunk fabric
- Flame resistant and guaranteed for the life of the garment
- Multi-purpose protection from electric arc and flash fire
- NAFTA - made with North American fabric and components
- CSA Z96-15 compliant
- Price competitive
- Avenger fabric is UL certified and meets the requirements of: NFPA 2112, CGSB 155.20, NFPA 70E, CSA Z462, ASTM F1506



STOCK COLOURS:



STOCK SIZES:

S	M	L	XL	2XL	3XL	4XL
---	---	---	----	-----	-----	-----

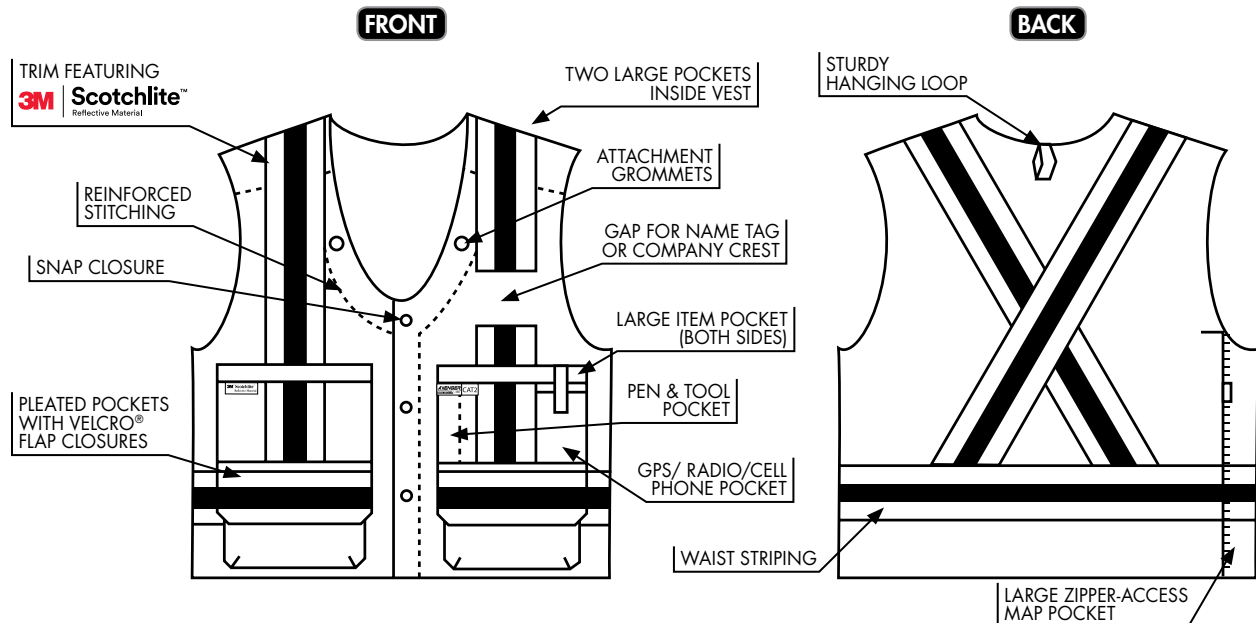

3M™ and Scotchlite™ are trademarks of 3M™ used under license by IFR Workwear Inc. in Canada.

THE TRUSTED LEADER IN QUALITY FLAME AND ARC RESISTANT WORKWEAR

www.ifrworkwear.ca | 403-347-5480 | info@ifrworkwear.ca

# Style 3215 - **AVENGER** 9 oz Insulated Parka

# Style 3225 - **AVENGER** 9 oz Insulated Bib Pants

Trim Featuring 3M™ Scotchlite™ Reflective Material

**SHELL:**

- 9 oz - FR 88% cotton, 12% nylon twill weave, preshrunk fabric
- Flame resistant and guaranteed for the life of the garment
- Lowered X striping on back to allow more room for company logo or hooded undergarment\*
- Flame resistant fleece lined hand pockets
- Multi-purpose protection from electric arc and flash fire
- Avenger fabric meets the requirements of: NFPA 2112, CGSB 155.20, NFPA 70E, CSA Z462, ASTM F1506

**INSULATION PACKAGE - 12 OZ QUILTED:**

- Wind and vapour barrier
- Modacrylic insulation (flame resistant)
- 88% cotton, 12% high tenacity nylon lining



STOCK COLOURS:



STOCK SIZES:

S	M	L	XL	2XL	3XL
-	-	LT	XLT	2XLT	3XLT

\*Hood provision is added to the new CSA Z96-15 standard.

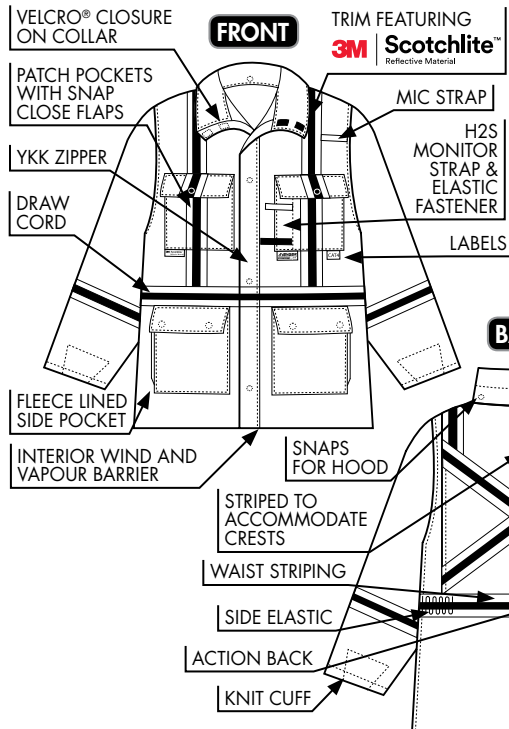

**NEW!**

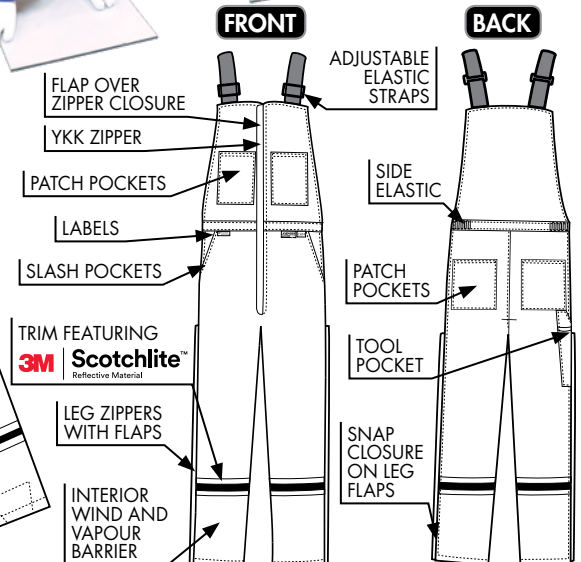

3M™ and Scotchlite™ are trademarks of 3M™ used under license by IFR Workwear Inc. in Canada.

THE TRUSTED LEADER IN QUALITY FLAME AND ARC RESISTANT WORKWEAR

www.ifrworkwear.ca | 403-347-5480 | info@ifrworkwear.ca



STAY **WARM**  
THIS **WINTER** WITH

**AVENGER**  
**WINTERWEAR**

Avenger flame resistant  
winterwear provides electric  
arc and flash fire protection  
plus warmth and durability  
you can depend on.





A close-up of a white fabric tag with a red and black logo. The logo consists of a red triangle pointing right, followed by a black dot, and the text "Westex UltraSoft" in a bold, sans-serif font. The tag is positioned in the upper left corner of the frame.

**Westex  
UltraSoft®**

A large, bold, black text overlay is centered in the lower half of the image. The text is set against a background of a blurred retail store interior with shelves and people. The text is contained within a white, angular graphic shape that overlaps the background.

**COMFORT &  
PROTECTION  
FOR ALL SEASONS**





NIER 02

## Style 102 - UltraSoft® 7 oz Deluxe Coveralls

Trim Featuring 3M™ Scotchlite™ Reflective Material

- 7 oz - 88% cotton, 12% high tenacity nylon from Westex®
- Engineered for flame resistance and guaranteed for the life of the garment
- 50% extended garment wear life over 100% cotton
- Soft feel of cotton comfort
- Multi-purpose protection from electric arc, flash fire and molten ferrous metal
- Breakaway zipper
- H2S monitor can attach to outside of pocket with strap and elastic fasteners
- No melt, no drip VELCRO®
- Lowered X striping on back to allow more room for company logo or hooded undergarment\*
- Westex UltraSoft® fabric meets the requirements of: NFPA 2112, CGSB 155.20, NFPA 70E, CSA Z462, ASTM F1506



STOCK COLOURS:

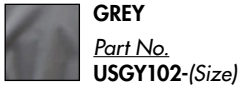

STOCK SIZES:

34	36	38	40	42	44	46	48	50	52	54	56	58	60	62	64-66
-	36T	38T	40T	42T	44T	46T	48T	50T	52T	54T	56T	58T	60T	62T	64T-66T

\*Hood provision is added to the new CSA Z96-15 standard.

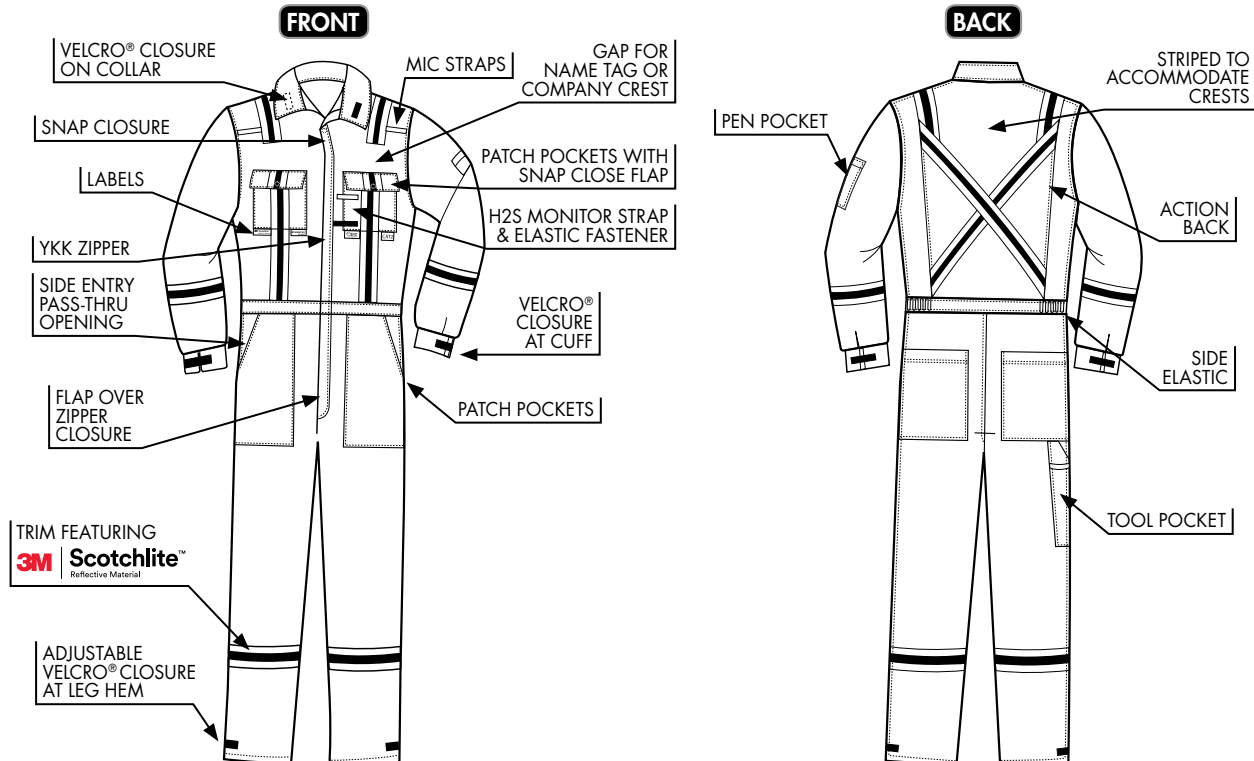

Westex UltraSoft® is a registered trademark of Westex® by Milliken® used under license by IFR Workwear Inc. 3M™ and Scotchlite™ are trademarks of 3M™ used under license by IFR Workwear Inc. in Canada.



# Style 106 - UltraSoft® 9 oz Contractor Coveralls

Trim Featuring 3M™ Scotchlite™ Reflective Material

- 9 oz - 88% cotton, 12% high tenacity nylon from Westex®
- Engineered for flame resistance and guaranteed for the life of the garment
- 50% extended garment wear life over 100% cotton
- Soft feel of cotton comfort
- Multi-purpose protection from electric arc, flash fire, molten ferrous metal and welding exposure
- Breakaway zipper
- No melt, no drip VELCRO®
- Lowered X striping on back to allow more room for company logo or hooded undergarment\*\*
- Westex UltraSoft® fabric meets the requirements of: NFPA 2112, CGSB 155.20, NFPA 70E, CSA Z462, ASTM F1506



STOCK COLOURS:



**GREEN**

Part No.  
USG106-(Size)



**GREY**

Part No.  
USGY106-(Size)

STOCK SIZES:

32*	34*	36*	38	40	42	44	46	48	50	52	54	56	58	60-62*	64-66*	68-70*
-	-	36T*	38T	40T	42T	44T	46T	48T	50T	52T	54T	56T	58T	60-62T*	64-66T*	68-70T*

\*All sizes not available in all colours, please call for availability.

\*\*Hood provision is added to the new CSA Z96-15 standard.

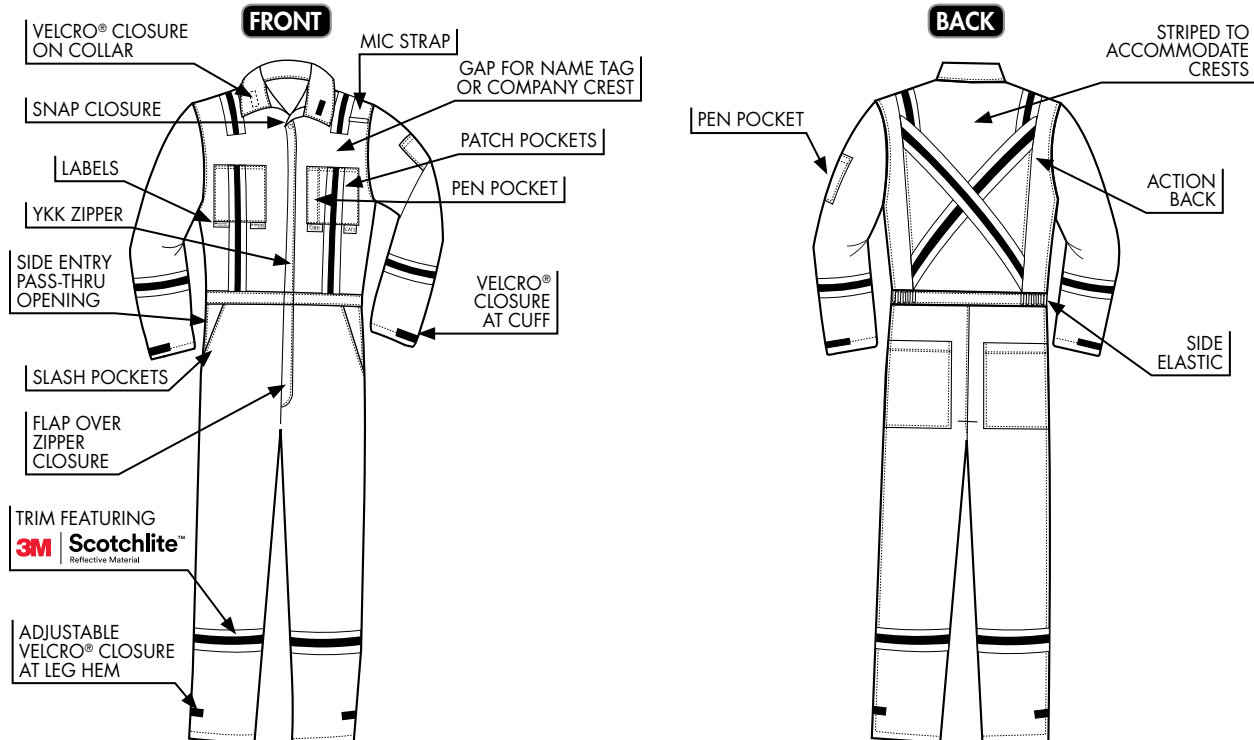

Westex UltraSoft® is a registered trademark of Westex® by Milliken® used under license by IFR Workwear Inc. 3M™ and Scotchlite™ are trademarks of 3M™ used under license by IFR Workwear Inc. in Canada.

THE TRUSTED LEADER IN QUALITY FLAME AND ARC RESISTANT WORKWEAR

www.ifrworkwear.ca | 403-347-5480 | info@ifrworkwear.ca

## Style 107 - UltraSoft® 7 oz Contractor Coveralls

Trim Featuring 3M™ Scotchlite™ Reflective Material

- 7 oz - 88% cotton, 12% high tenacity nylon from Westex®
- Engineered for flame resistance and guaranteed for the life of the garment
- 50% extended garment wear life over 100% cotton
- Soft feel of cotton comfort
- Multi-purpose protection from electric arc, flash fire and molten ferrous metal
- Breakaway zipper
- No melt, no drip VELCRO®
- Lowered X striping on back to allow more room for company logo or hooded undergarment\*
- Westex UltraSoft® fabric meets the requirements of: NFPA 2112, CGSB 155.20, NFPA 70E, CSA Z462, ASTM F1506



STOCK COLOURS:



STOCK SIZES:

34	36	38	40	42	44	46	48	50	52	54	56	58	60-62	64-66
-	-	38T	40T	42T	44T	46T	48T	50T	52T	54T	56T	58T	60T-62T	64T-66T

\*Hood provision is added to the new CSA Z96-15 standard.

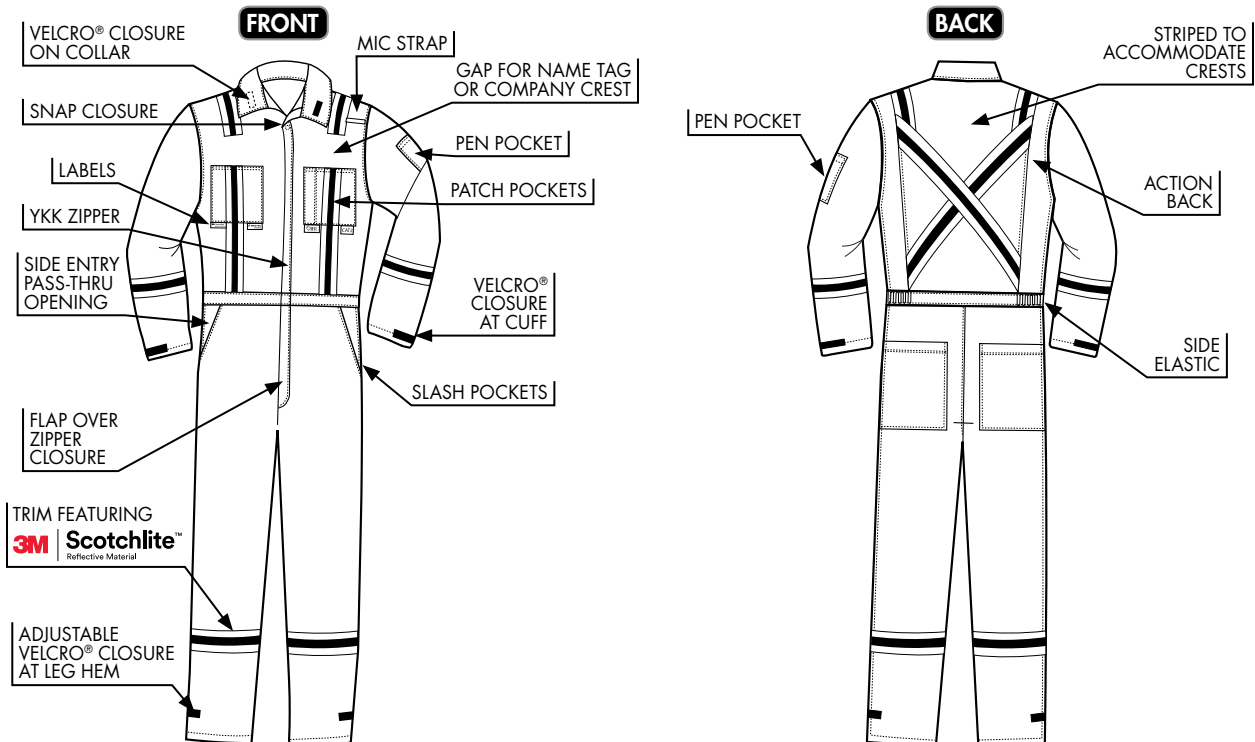

Westex UltraSoft® is a registered trademark of Westex® by Milliken® used under license by IFR Workwear Inc. 3M™ and Scotchlite™ are trademarks of 3M™ used under license by IFR Workwear Inc. in Canada.

# Style 108 - UltraSoft® 7 oz CSA Deluxe Coveralls

Trim Featuring 3M™ Scotchlite™ Reflective Material

- 7 oz - 88% cotton, 12% high tenacity nylon from Westex®
- Engineered for flame resistance and guaranteed for the life of the garment
- 50% extended garment wear life over 100% cotton
- Soft feel of cotton comfort
- Multi-purpose protection from electric arc, flash fire and molten ferrous metal
- Breakaway zipper
- H2S monitor can attach to outside of pocket with strap and elastic fasteners
- No melt, no drip VELCRO®
- Lowered X striping on back to allow more room for company logo or hooded undergarment\*\*
- Westex UltraSoft® fabric meets the requirements of: NFPA 2112, CGSB 155.20, NFPA 70E, CSA Z462, ASTM F1506



STOCK COLOURS:



STOCK SIZES:

34*	36*	38	40	42	44	46	48	50	52	54	56	58
-	-	38T	40T	42T	44T	46T	48T	50T	52T	54T	56T	58T

\*May be a non-stocked item, please call for availability.

\*\*Hood provision is added to the new CSA Z96-15 standard.

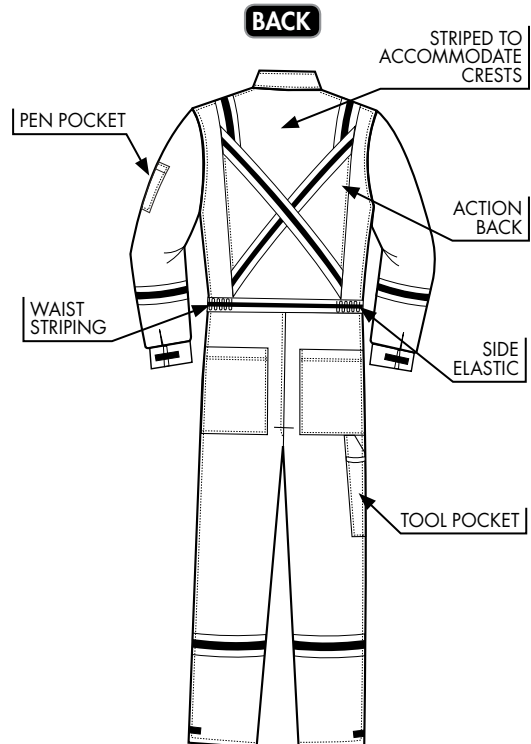
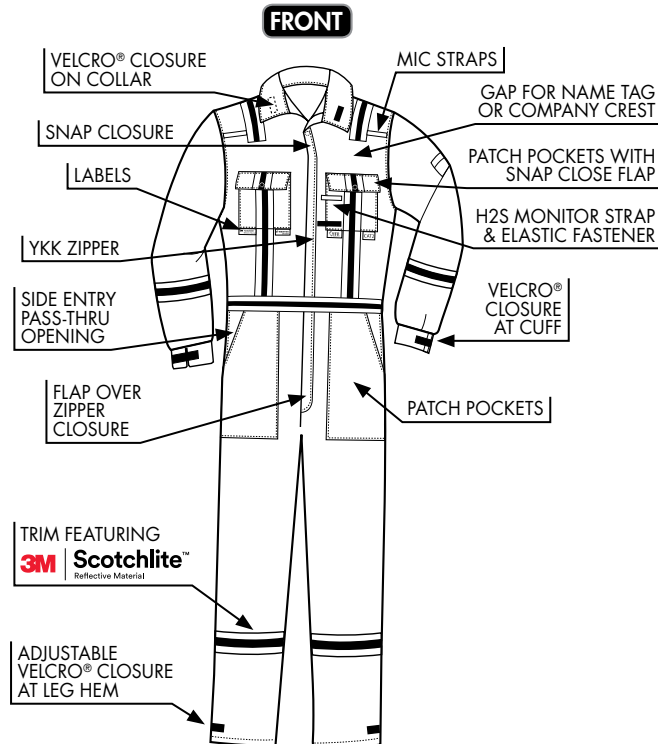

Westex UltraSoft® is a registered trademark of Westex® by Milliken® used under license by IFR Workwear Inc. 3M™ and Scotchlite™ are trademarks of 3M™ used under license by IFR Workwear Inc. in Canada.

THE TRUSTED LEADER IN QUALITY FLAME AND ARC RESISTANT WORKWEAR

www.ifrworkwear.ca | 403-347-5480 | info@ifrworkwear.ca



## Style 109 - UltraSoft® 9 oz CSA Deluxe Coveralls

Trim Featuring 3M™ Scotchlite™ Reflective Material

- 9 oz - 88% cotton, 12% high tenacity nylon from Westex®
- Engineered for flame resistance and guaranteed for the life of the garment
- 50% extended garment wear life over 100% cotton
- Soft feel of cotton comfort
- Multi-purpose protection from electric arc, flash fire, molten ferrous metal and welding exposure
- Breakaway zipper
- H2S monitor can attach to outside of pocket with strap and elastic fasteners
- No melt, no drip VELCRO®
- Lowered X striping on back to allow more room for company logo or hooded undergarment\*\*
- Westex UltraSoft® fabric meets the requirements of: NFPA 2112, CGSB 155.20, NFPA 70E, CSA Z462, ASTM F1506



STOCK COLOURS:



STOCK SIZES:

34*	36	38	40	42	44	46	48	50	52	54	56	58	60-62	64-66	68-70*
34T*	36T	38T	40T	42T	44T	46T	48T	50T	52T	54T	56T	58T	60T-62T	64T-66T	68T-70T*

\*All sizes not available in all colours, please call for availability.

\*\*Hood provision is added to the new CSA Z96-15 standard.

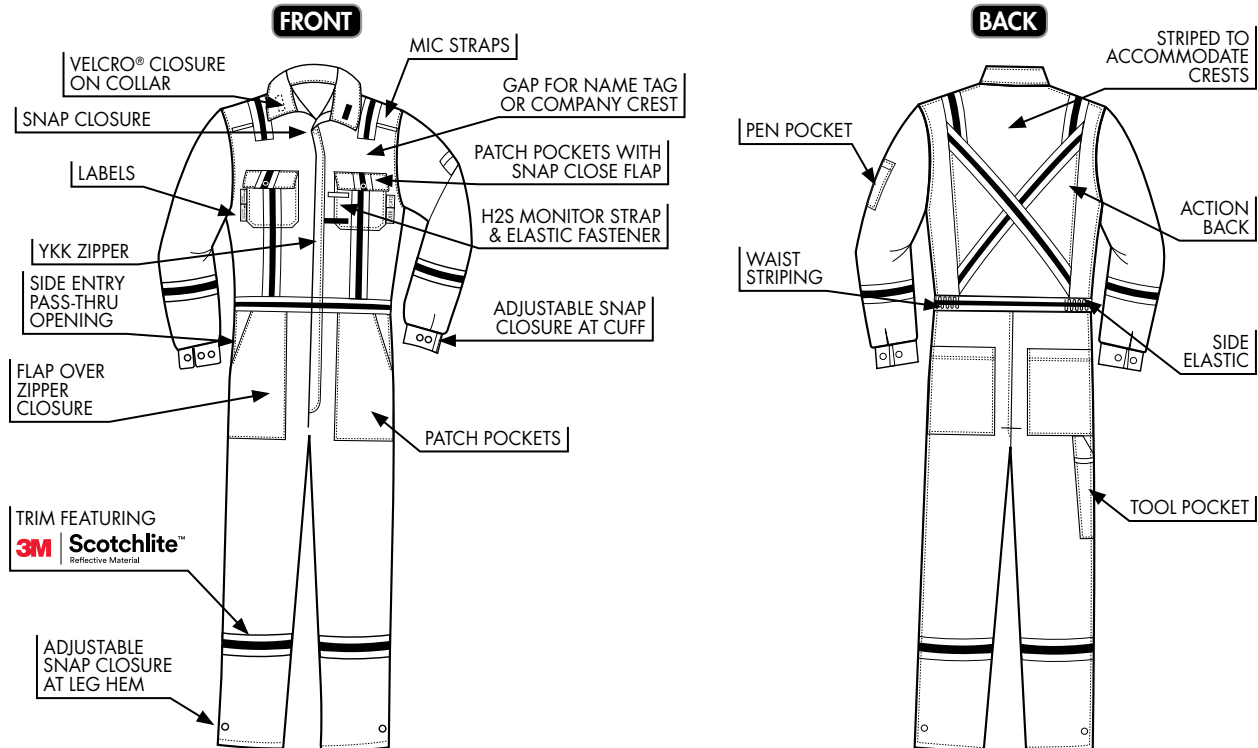

Westex UltraSoft® is a registered trademark of Westex® by Milliken® used under license by IFR Workwear Inc. 3M™ and Scotchlite™ are trademarks of 3M™ used under license by IFR Workwear Inc. in Canada.

# Style 112 - UltraSoft® 9 oz Skyline Summer Bomber

Trim Featuring 3M™ Scotchlite™ Reflective Material

- 9 oz - 88% cotton, 12% high tenacity nylon shell from Westex®
- 7 oz - 88% cotton, 12% high tenacity nylon lining from Westex®
- Engineered for flame resistance and guaranteed for the life of the garment
- 50% extended garment wear life over 100% cotton
- Soft feel of cotton comfort
- Multi-purpose protection from electric arc, flash fire, molten ferrous metal and welding exposure
- No melt, no drip VELCRO®
- Lowered X striping on back to allow more room for company logo or hooded undergarment\*\*
- Westex UltraSoft® fabric meets the requirements of: NFPA 2112, CGSB 155.20, NFPA 70E, CSA Z462, ASTM F1506



STOCK COLOURS:



STOCK SIZES:

S	M	L	XL	2XL	3XL	4XL
ST*	MT*	LT	XLT	2XLT	3XLT	4XLT

\*May be a non-stocked item, please call for availability.

\*\*Hood provision is added to the new CSA Z96-15 standard.

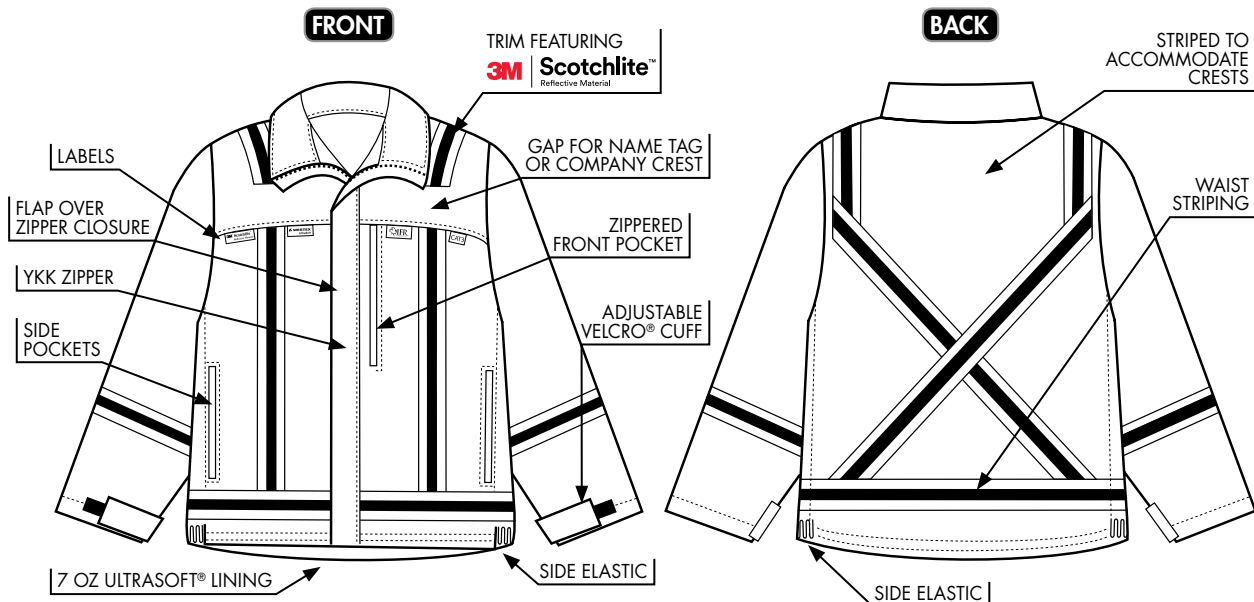

Westex UltraSoft® is a registered trademark of Westex® by Milliken® used under license by IFR Workwear Inc. 3M™ and Scotchlite™ are trademarks of 3M™ used under license by IFR Workwear Inc. in Canada.

THE TRUSTED LEADER IN QUALITY FLAME AND ARC RESISTANT WORKWEAR

www.ifrworkwear.ca | 403-347-5480 | info@ifrworkwear.ca

# Style 150 - UltraSoft® 9 oz *Suit-All* Top

# Style 151 - UltraSoft® 9 oz *Suit-All* Bottom

Trim Featuring 3M™ Scotchlite™ Reflective Material

- 9 oz - 88% cotton, 12% high tenacity nylon from Westex®
- Engineered for flame resistance and guaranteed for the life of the garment
- 50% extended garment wear life over 100% cotton
- Soft feel of cotton comfort
- Multi-purpose protection from electric arc, flash fire, molten ferrous metal and welding exposure
- H2S monitor can attach to outside of pocket with strap and elastic fasteners
- Westex UltraSoft® fabric meets the requirements of: NFPA 2112, CGSB 155.20, NFPA 70E, CSA Z462, ASTM F1506



© Canadian Patent Design No. 148755  
US Patent Design No. D731,750



STOCK COLOURS:



STOCK SIZES:

34	36	38	40	42	44	46	48	50	52-54	56-58
34T*	36T*	38T*	40T	42T	44T	46T	48T	50T	52T-54T	56T-58T

For Hi-Vis Orange, see styles 452 & 453 on page 15.

\*May be a non-stocked item, please call for availability. Regular size Suit-All Tops were designed to fit women or shorter men, and the tall size will fit most men. UltraSoft® Suit-All Top can also be worn with UltraSoft® Bib Pants - Style 122.

Suit-All Bottoms are measured with standard coverall sizing, **not** waist sizing and are only available in regular sizes, not tall.

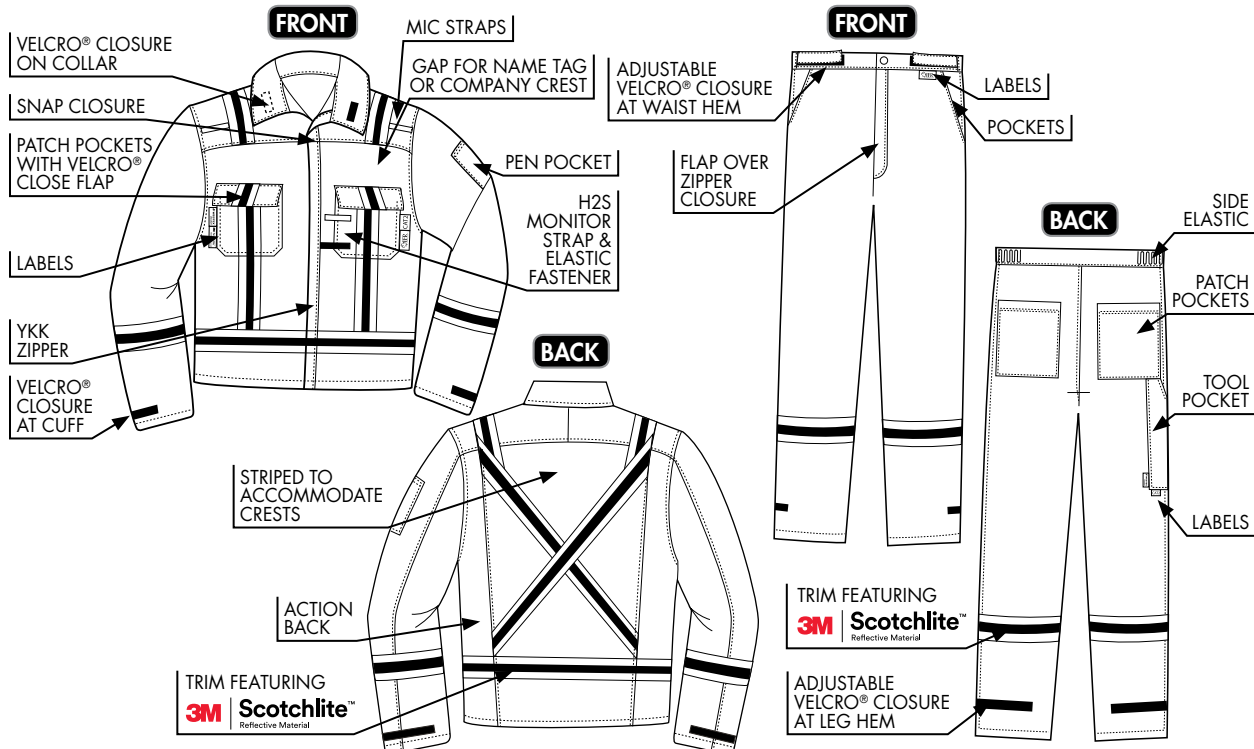

Westex UltraSoft® is a registered trademark of Westex® by Milliken® used under license by IFR Workwear Inc. 3M™ and Scotchlite™ are trademarks of 3M™ used under license by IFR Workwear Inc. in Canada.



# Style 122 - UltraSoft® 9 oz Bib Pants

Trim Featuring 3M™ Scotchlite™ Reflective Material

- 9 oz - 88% cotton, 12% high tenacity nylon from Westex®
- Engineered for flame resistance and guaranteed for the life of the garment
- 50% extended garment wear life over 100% cotton
- Soft feel of cotton comfort
- Multi-purpose protection from electric arc, flash fire, molten ferrous metal and welding exposure
- Westex UltraSoft® fabric meets the requirements of: NFPA 2112, CGSB 155.20, NFPA 70E, CSA Z462, ASTM F1506



STOCK COLOURS:



STOCK SIZES:

S	M	L	XL	2XL	3XL	4XL
-	MT	LT	XLT	2XLT	3XLT	4XLT

*Pairs Perfectly With:*  
**Suit-All Top or Skyline Bomber**  
 (Style 150 on page 47 or style 112 on page 46)

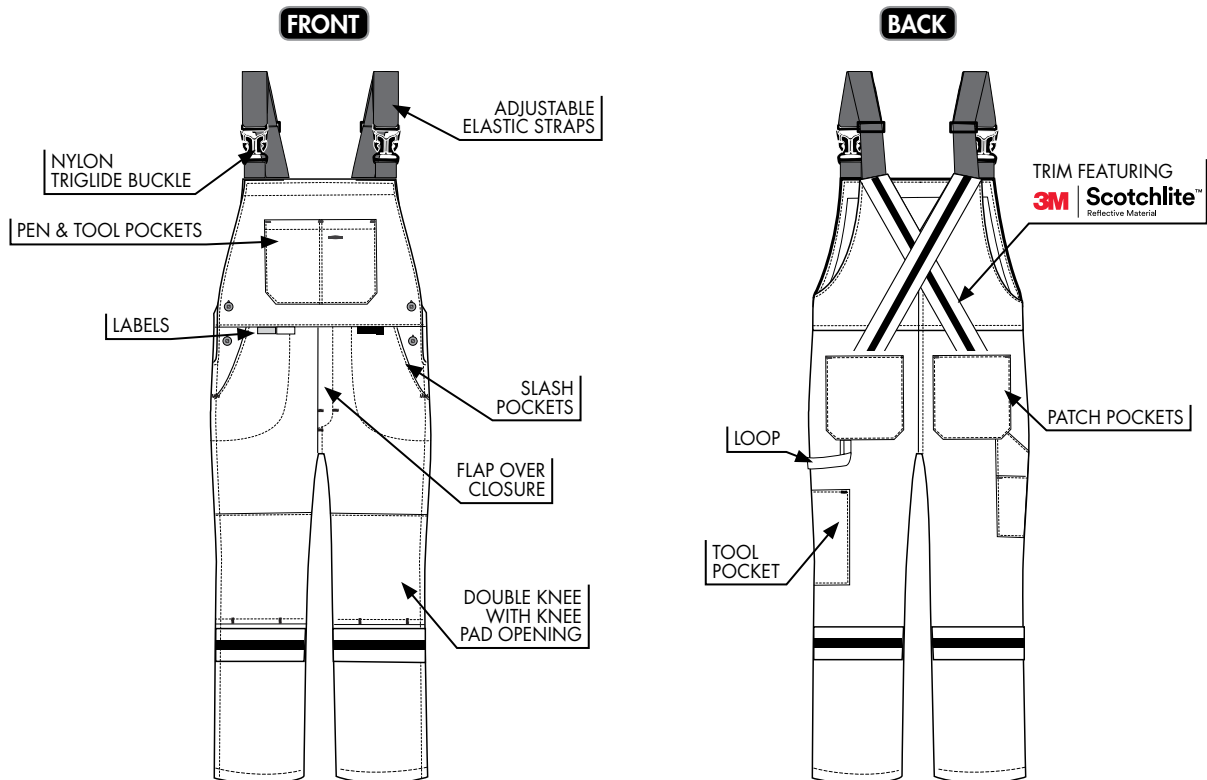

Westex UltraSoft® is a registered trademark of Westex® by Milliken® used under license by IFR Workwear Inc. 3M™ and Scotchlite™ are trademarks of 3M™ used under license by IFR Workwear Inc. in Canada.

THE TRUSTED LEADER IN QUALITY FLAME AND ARC RESISTANT WORKWEAR

www.ifrworkwear.ca | 403-347-5480 | info@ifrworkwear.ca

## Style 611 - UltraSoft® 9 oz Cargo Pants

## Style 612 - UltraSoft® 7 oz Cargo Pants

- 88% cotton, 12% high tenacity nylon from Westex®
- Engineered for flame resistance and guaranteed for the life of the garment
- 50% extended garment wear life over 100% cotton
- Soft feel of cotton comfort
- Multi-purpose protection from electric arc, flash fire, molten ferrous metal and welding exposure
- Westex UltraSoft® fabric meets the requirements of: NFPA 2112, CGSB 155.20, NFPA 70E, CSA Z462, ASTM F1506

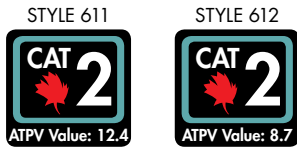

STOCK COLOURS:



STOCK UNHEMMED SIZES: *(Can be hemmed in-house before shipping)*

28	30	32	34	36	38	40	42	44	46	48	50
----	----	----	----	----	----	----	----	----	----	----	----

*36" unhemmed leg length. Pants are measured using standard waist sizing.*

STOCKED PREHEMMED SIZES: (STYLE 611 ONLY)

32x30	32x32	34x30	34x32	34x34	36x30	36x32	36x34	38x30	38x32
-------	-------	-------	-------	-------	-------	-------	-------	-------	-------

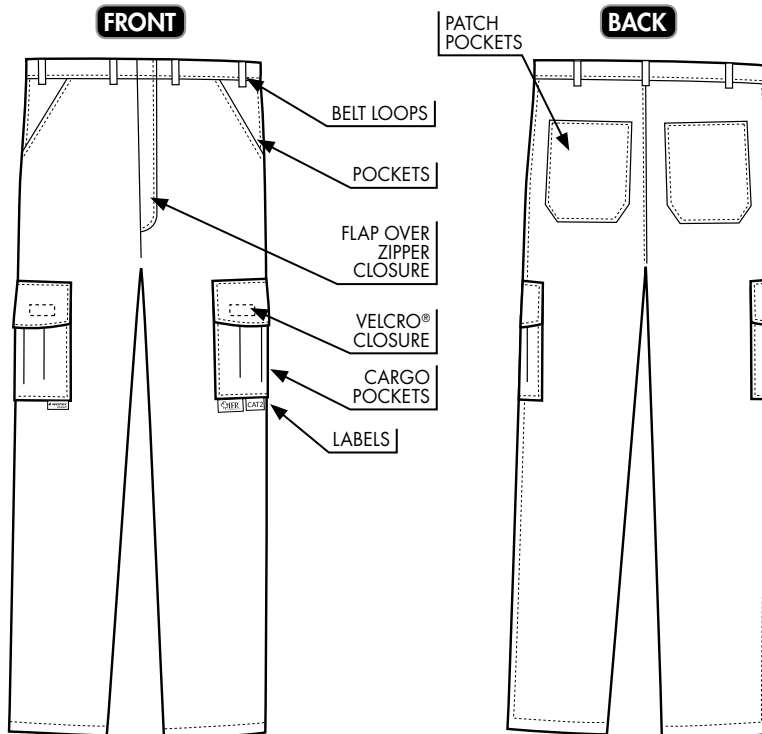

*Pairs Perfectly With:*

### Leather Belt

Style 1750 - see page 91

- Made with durable leather
- Leather is inherently flame resistant
- Fastens with FR VELCRO®, easily adjustable, tear-away style
- Absence of buckles prevents electrical arcing, static shock, snagging, and other potential workplace hazards in various industries such as electrical and oilfield
- Airport friendly

Westex UltraSoft® is a registered trademark of Westex® by Milliken® used under license by IFR Workwear Inc.

## Style 650 - UltraSoft® 7 oz Deluxe Work Shirt

## Style 650 - UltraSoft® 7 oz Deluxe Striped Work Shirt

2" Trim Featuring 3M™ Scotchlite™ Reflective Material

- 7 oz - 88% cotton, 12% high tenacity nylon from Westex®
- Engineered for flame resistance and guaranteed for the life of the garment
- 50% extended garment wear life over 100% cotton
- Soft feel of cotton comfort
- Multi-purpose protection from electric arc, flash fire and molten ferrous metal
- Westex UltraSoft® fabric meets the requirements of: NFPA 2112, CGSB 155.20, NFPA 70E, CSA Z462, ASTM F1506



STOCK COLOURS:



\*USN650 ONLY

STOCK SIZES:

S	M	L	XL	2XL	3XL	4XL*
-	MT	LT	XLT	2XLT	3XLT*	4XLT*

For Hi-Vis Orange, see styles 651 & 652 on page 17.



\*All sizes not available in all colours, please call for availability.

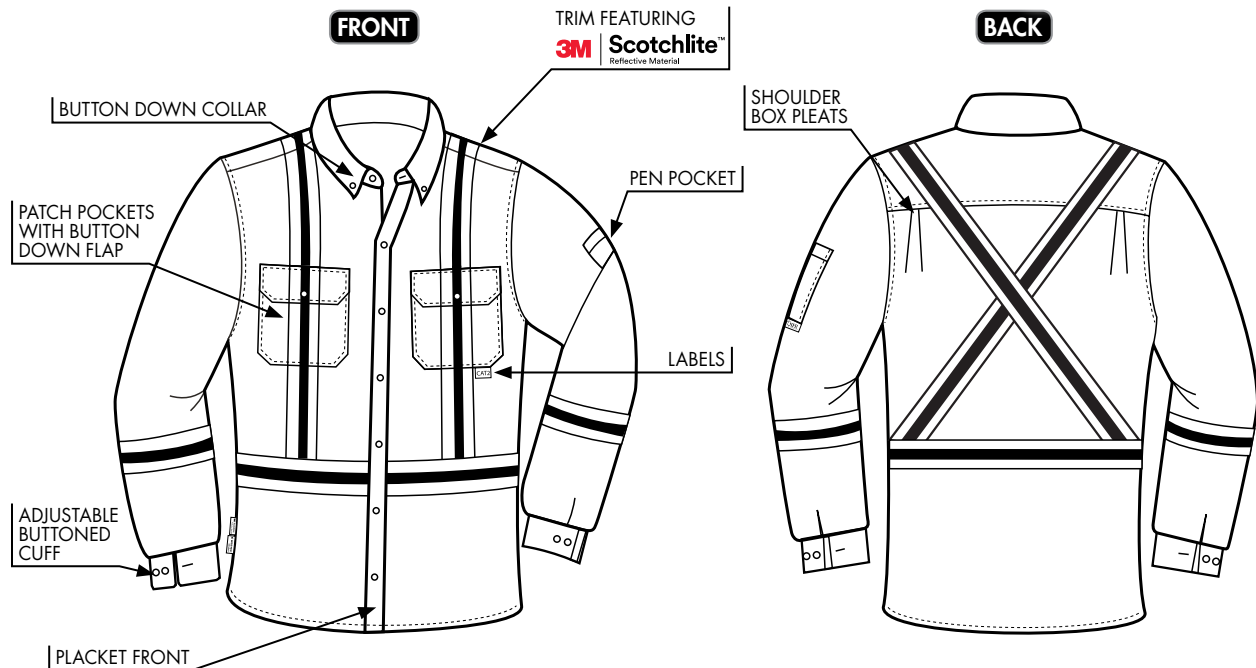

Westex UltraSoft® is a registered trademark of Westex® by Milliken® used under license by IFR Workwear Inc.

THE TRUSTED LEADER IN QUALITY FLAME AND ARC RESISTANT WORKWEAR

www.ifrworkwear.ca | 403-347-5480 | info@ifrworkwear.ca



## Style 660 - UltraSoft® 6 oz Henley Long Sleeve T-Shirt

- 6 oz - 88% cotton, 12% high tenacity nylon knit from Westex®
- Engineered for flame resistance and guaranteed for the life of the garment
- 50% extended garment wear life over 100% cotton
- Soft feel of cotton comfort
- Multi-purpose protection from electric arc and molten ferrous metal
- Westex UltraSoft® knit fabric meets the requirements of:  
ASTM F1506, NFPA 70E, CSA Z462



STOCK COLOURS:



STOCK SIZES:

S	M	L	XL	2XL	3XL	4XL
-	MT	LT	XLT	2XLT	3XLT	4XLT

For Hi-Vis **Orange Striped**,  
see styles 661 & 662  
on page 18.



**FRONT**

BUTTON  
DOWN COLLAR



CHEST POCKET

**BACK**

LABELS

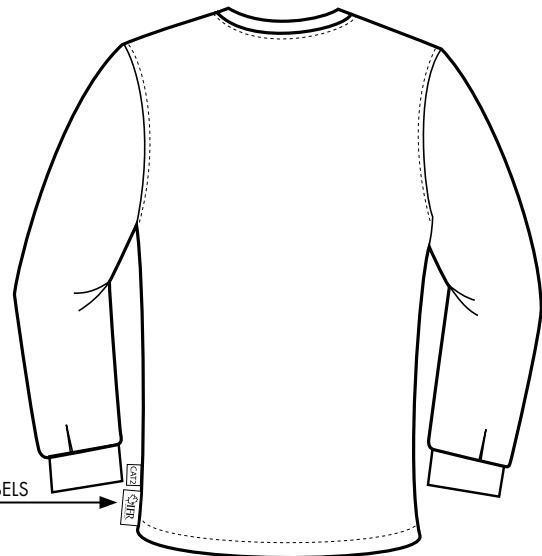

Westex UltraSoft® is a registered trademark of Westex® by Milliken® used under license by IFR Workwear Inc.

# Style 201 - UltraSoft® 9 oz Insulated Coveralls

Trim Featuring 3M™ Scotchlite™ Reflective Material

### SHELL:

- 9 oz - 88% cotton, 12% high tenacity nylon from Westex®
- Engineered for flame resistance and guaranteed for the life of the garment
- No melt, no drip VELCRO®
- Lowered X striping on back to allow more room for company logo or hooded undergarment\*
- Multi-purpose protection from electric arc, flash fire, molten ferrous metal and welding exposure
- Westex UltraSoft® fabric meets the requirements of: NFPA 2112, CGSB 155.20, NFPA 70E, CSA Z462, ASTM F1506

### INSULATION PACKAGE - 12 OZ QUILTED:

- Wind and vapour barrier
- Modacrylic insulation (flame resistant)
- 88% cotton, 12% high tenacity nylon lining



STOCK COLOURS:



STOCK SIZES:

S	M	L	XL	2XL	3XL	4XL
-	-	LT	XLT	2XLT	3XLT	4XLT

\*Hood provision is added to the new CSA Z96-15 standard.



*Pairs Perfectly With:*  
**Insulated Parka Hood**  
 Style 265 - see page 56

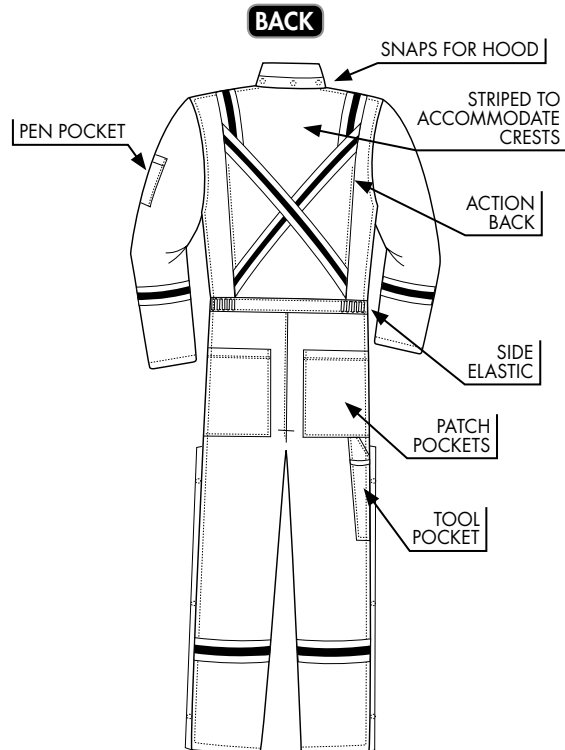
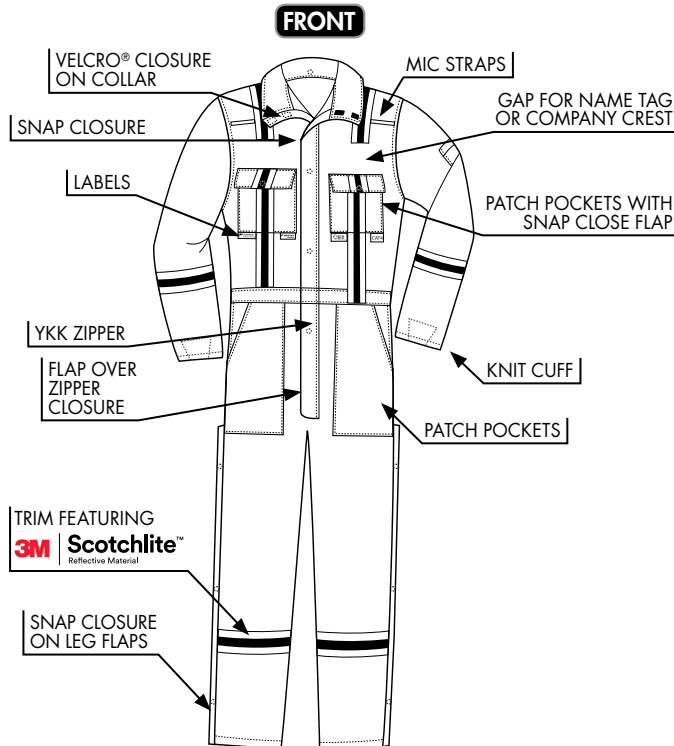

Westex UltraSoft® is a registered trademark of Westex® by Milliken® used under license by IFR Workwear Inc. 3M™ and Scotchlite™ are trademarks of 3M™ used under license by IFR Workwear Inc. in Canada.

# Style 215 - UltraSoft® 9 oz Insulated Parka

# Style 225 - UltraSoft® 9 oz Insulated Bib Pants

Trim Featuring 3M™ Scotchlite™ Reflective Material

**SHELL:**

- 9 oz - 88% cotton, 12% high tenacity nylon from Westex®
- Engineered for flame resistance and guaranteed for the life of the garment
- H2S monitor can attach to outside of pocket with strap and elastic fasteners
- Lowered X striping on back to allow more room for company logo or hooded undergarment\*\*
- Flame resistant fleece lined hand pockets
- Multi-purpose protection from electric arc, flash fire, molten ferrous metal and welding exposure
- Westex UltraSoft® fabric meets the requirements of: NFPA 2112, CGSB 155.20, NFPA 70E, CSA Z462, ASTM F1506

**INSULATION PACKAGE - 12 OZ QUILTED:**

- Wind and vapour barrier
- Modacrylic insulation (flame resistant)
- 88% cotton, 12% high tenacity nylon lining



**NAVY**  
Part No.  
USN215-(Size)  
USN225-(Size)

**GREEN**  
Part No.  
USG215-(Size)  
USG225-(Size)

STOCK COLOURS:

**ROYAL BLUE**  
Part No.  
USB215-(Size)  
USB225-(Size)

**RED**  
Part No.  
USR215-(Size)  
USR225-(Size)

**GREY**  
Part No.  
USGY215-(Size)  
USGY225-(Size)

STOCK SIZES:

XS*	S	M	L	XL	2XL	3XL	4XL	5XL*
-	ST*	MT*	LT	XLT	2XLT	3XLT	4XLT*	5XLT*

\*All sizes not available in all colours, please call for availability.  
\*\*Hood provision is added to the new CSA Z96-15 standard.

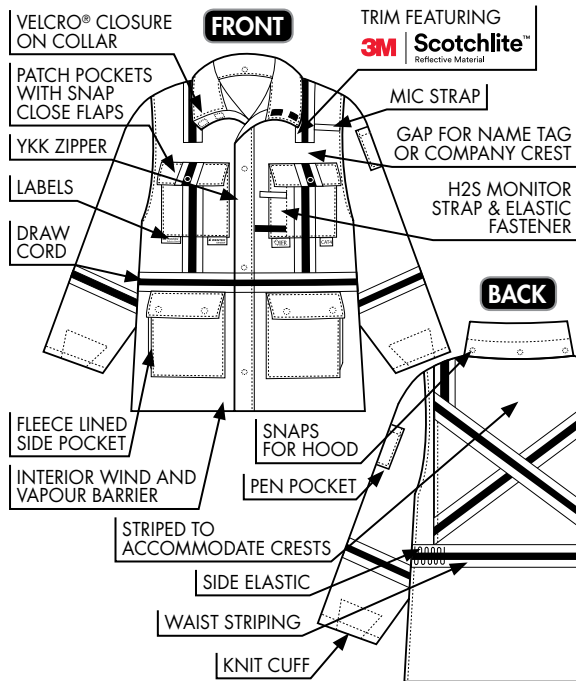

For Hi-Vis Orange, see styles 515 & 525 on page 24.

*Pairs Perfectly With:*  
**Insulated Parka Hood**  
Style 265 - see page 56

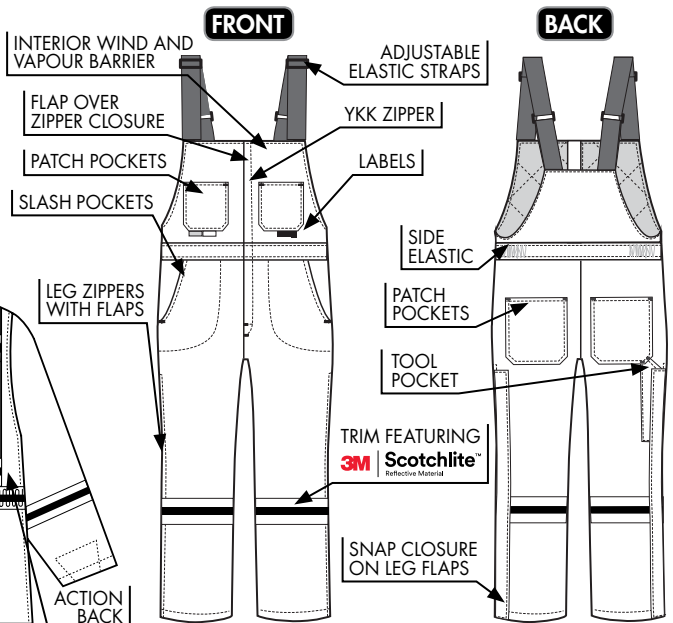

Westex UltraSoft® is a registered trademark of Westex® by Milliken® used under license by IFR Workwear Inc. 3M™ and Scotchlite™ are trademarks of 3M™ used under license by IFR Workwear Inc. in Canada.



# Style 216 - UltraSoft® 9 oz Insulated Bomber

Trim Featuring 3M™ Scotchlite™ Reflective Material

### SHELL:

- 9 oz - 88% cotton, 12% high tenacity nylon from Westex®
- Engineered for flame resistance and guaranteed for the life of the garment
- H2S monitor can attach to outside of pocket with strap and elastic fasteners
- No melt, no drip VELCRO®
- Lowered X striping on back to allow more room for company logo or hooded undergarment\*
- Flame resistant fleece lined hand pockets
- Multi-purpose protection from electric arc, flash fire, molten ferrous metal and welding exposure
- Westex UltraSoft® fabric meets the requirements of: NFPA 2112, CGSB 155.20, NFPA 70E, CSA Z462, ASTM F1506

### INSULATION PACKAGE - 12 OZ QUILTED:

- Wind and vapour barrier
- Modacrylic insulation (flame resistant)
- 88% cotton, 12% high tenacity nylon lining



STOCK COLOURS:



STOCK SIZES:

S	M	L	XL	2XL	3XL	4XL
ST	MT	LT	XLT	2XLT	3XLT	4XLT

\*Hood provision is added to the new CSA Z96-15 standard.



Pairs Perfectly With:  
Insulated Parka Hood  
Style 265 - see page 56

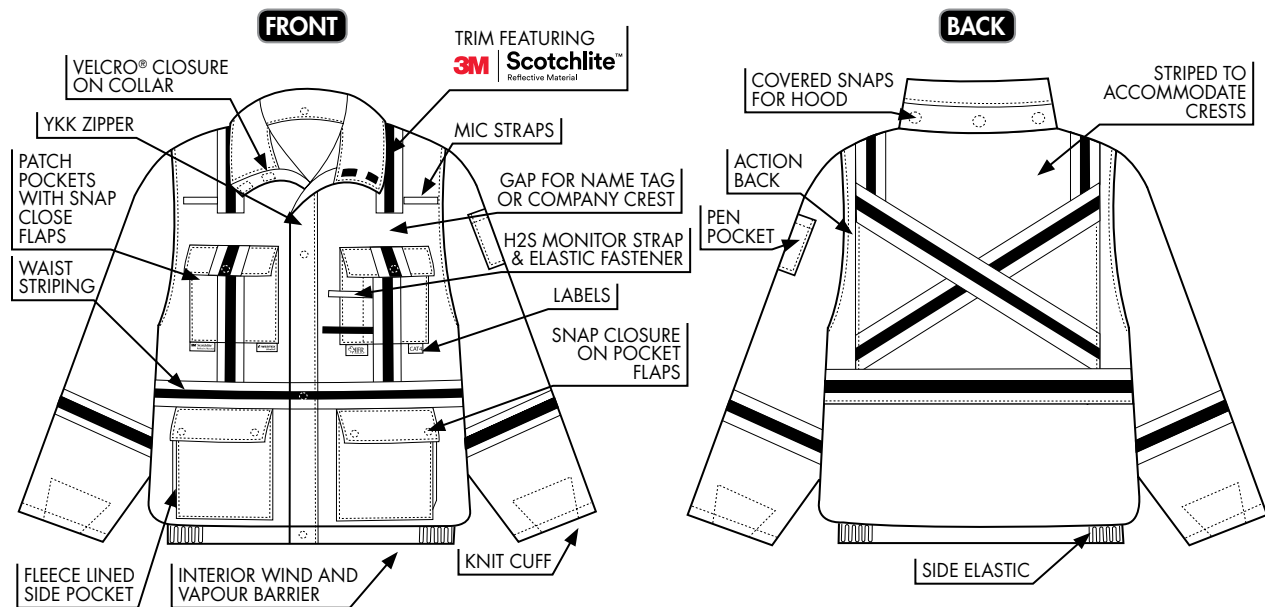

Westex UltraSoft® is a registered trademark of Westex® by Milliken® used under license by IFR Workwear Inc. 3M™ and Scotchlite™ are trademarks of 3M™ used under license by IFR Workwear Inc. in Canada.

## Style 240 - UltraSoft® 9 oz Insulated Vest

Trim Featuring 3M™ Scotchlite™ Reflective Material

### SHELL:

- 9 oz - 88% cotton, 12% high tenacity nylon from Westex®
- Engineered for flame resistance and guaranteed for the life of the garment
- H2S monitor can attach to outside of pocket with strap and elastic fasteners
- Lowered X striping on back to allow more room for company logo or hooded undergarment\*
- Multi-purpose protection from electric arc, flash fire, molten ferrous metal and welding exposure
- Westex UltraSoft® fabric meets the requirements of: NFPA 2112, CGSB 155.20, NFPA 70E, CSA Z462, ASTM F1506

### INSULATION PACKAGE - 12 OZ QUILTED:

- Wind and vapour barrier
- Modacrylic insulation (flame resistant)
- 88% cotton, 12% high tenacity nylon lining



### STOCK COLOURS:



### STOCK SIZES:

S	M	L	XL	2XL	3XL	4XL
---	---	---	----	-----	-----	-----

\*Hood provision is added to the new CSA Z96-15 standard.

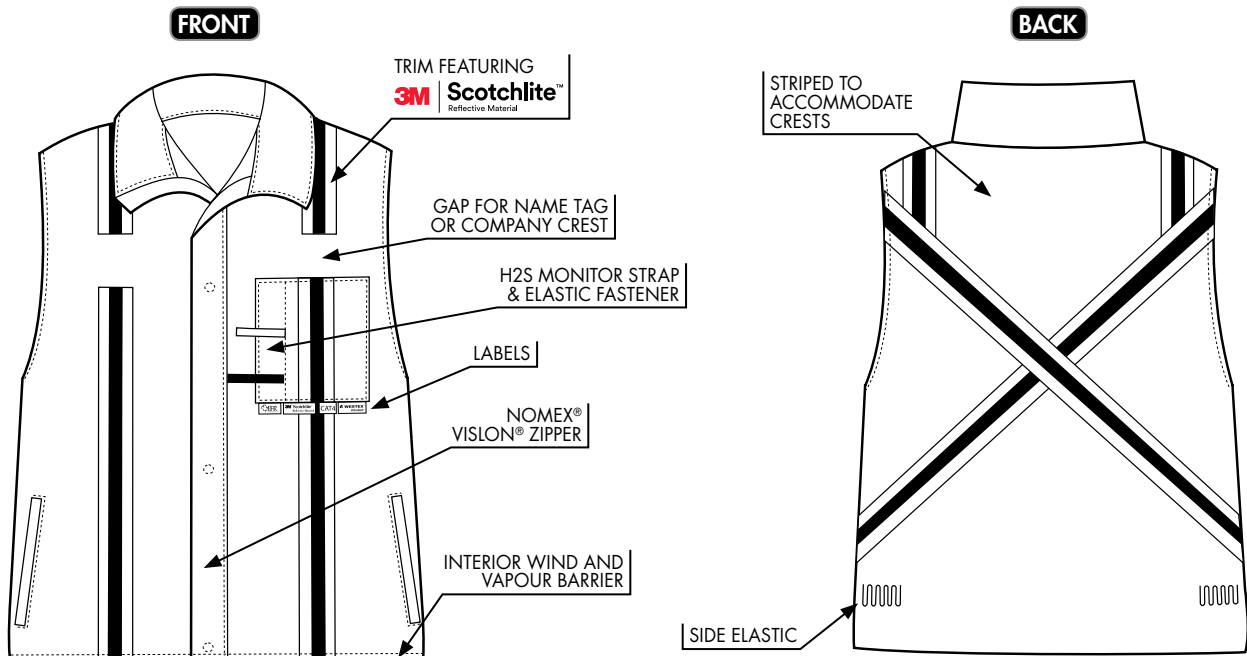

Westex UltraSoft® is a registered trademark of Westex® by Milliken® used under license by IFR Workwear Inc. 3M™ and Scotchlite™ are trademarks of 3M™ used under license by IFR Workwear Inc. in Canada.

## Style 265 - UltraSoft® 9 oz Insulated Parka Hood



These hoods are designed to attach to our Westex UltraSoft® parkas, and fit over hard hats for flame resistance and maximum protection against the elements. The unique design provides maximum peripheral vision.

**ONE SIZE FITS ALL**

STOCK COLOURS:

 <b>ROYAL BLUE</b> <i>Part No.</i> <b>UPB265</b>	 <b>NAVY</b> <i>Part No.</i> <b>UPN265</b>
 <b>GREEN</b> <i>Part No.</i> <b>UPG265</b>	 <b>GREY</b> <i>Part No.</i> <b>UPGY265</b>
 <b>RED</b> <i>Part No.</i> <b>UPR265</b>	 <b>ORANGE</b> <i>Part No.</i> <b>UPO265</b>

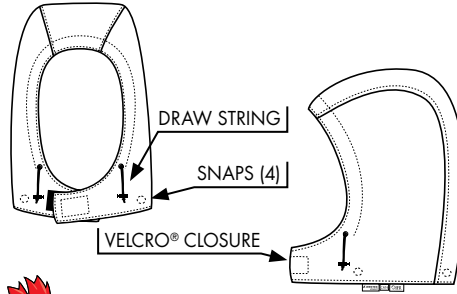

**Attaches to Styles: 201, 215, 216, 413, 513, 515**

## Style 275 - UltraSoft® 9 oz Insulated Broiler Hard Hat Liner



The broiler hard hat liner is designed to go with our Westex UltraSoft® insulated winterwear, and fit under hard hats for flame resistance and maximum protection against the elements. The unique design includes a neck cowl and comes with a removable nose cover designed to prevent safety glasses from fogging see diagram below.

**ONE SIZE FITS ALL**

STOCK COLOURS:

 <b>ROYAL BLUE</b> <i>Part No.</i> <b>UPB275</b>	 <b>NAVY</b> <i>Part No.</i> <b>UPN275</b>
 <b>GREEN</b> <i>Part No.</i> <b>UPG275</b>	 <b>GREY</b> <i>Part No.</i> <b>UPGY275</b>
 <b>RED</b> <i>Part No.</i> <b>UPR275</b>	 <b>ORANGE</b> <i>Part No.</i> <b>UPO275</b>

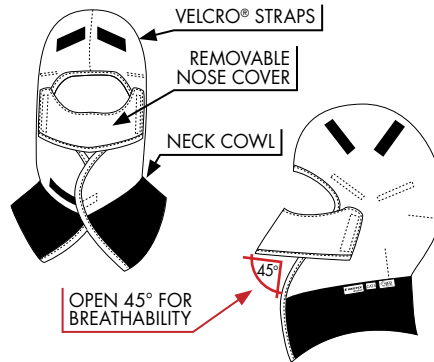

## Style 285 - UltraSoft® 9 oz Insulated Hard Hat Liner



These hard hat liners are designed to go with our Westex UltraSoft® insulated winterwear, and fit under hard hats for flame resistance and maximum protection against the elements. The unique design provides maximum peripheral vision.

**ONE SIZE FITS ALL**

STOCK COLOURS:

 <b>ROYAL BLUE</b> <i>Part No.</i> <b>UPB285</b>	 <b>NAVY</b> <i>Part No.</i> <b>UPN285</b>
 <b>GREEN</b> <i>Part No.</i> <b>UPG285</b>	 <b>GREY</b> <i>Part No.</i> <b>UPGY285</b>
 <b>RED</b> <i>Part No.</i> <b>UPR285</b>	 <b>ORANGE</b> <i>Part No.</i> <b>UPO285</b>

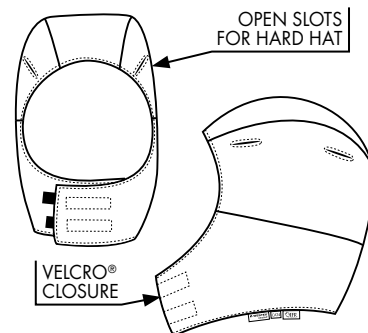

Westex UltraSoft® is a registered trademark of Westex® by Milliken® used under license by IFR Workwear Inc.

THE TRUSTED LEADER IN QUALITY FLAME AND ARC RESISTANT WORKWEAR

www.ifrworkwear.ca | 403-347-5480 | info@ifrworkwear.ca



## Style 196 - UltraSoft® 9 oz Arm Band

- 9 oz - 88% cotton, 12% high tenacity nylon from Westex®
- Engineered for flame resistance and guaranteed for the life of the garment
- VELCRO® closure
- Westex UltraSoft® fabric meets the requirements of:  
ASTM F1506, CGSB 155.20, CSA Z462, NFPA 2112, NFPA 70E

**ONE SIZE FITS ALL**



STOCK COLOURS:



### ARM BAND

Wraps around the arms to control sleeve shape, reduces snagging and catching hazard.



## Style 195 - UltraSoft® 9 oz Leg Band

- 9 oz - 88% cotton, 12% high tenacity nylon from Westex®
- Engineered for flame resistance and guaranteed for the life of the garment
- VELCRO® closure
- Westex UltraSoft® fabric meets the requirements of:  
ASTM F1506, CGSB 155.20, CSA Z462, NFPA 2112, NFPA 70E

**ONE SIZE FITS ALL**



STOCK COLOURS:



### LEG BAND

Wraps around the legs to control pant leg shape, reduces tripping and snagging hazard.



Westex UltraSoft® is a registered trademark of Westex® by Milliken® used under license by IFR Workwear Inc.



**Westex<sup>®</sup>**  
**DH**

**DESIGNED FOR  
PROTECTION.  
OPTIMIZED FOR  
COMFORT.**

**EXCELLENT MULTI-HAZARD PROTECTION**

NFPA 2112 • NFPA 70E Category 2 • ANSI 107

Learn more about  
Westex<sup>®</sup> DH  
FR fabric at  
[westex.com/DH](https://westex.com/DH)



Follow Us on Social Media

Lightweight and breathable Westex<sup>®</sup> DH flame resistant fabric is designed to keep you cooler, drier and more comfortable while delivering dual hazard FR protection. With its uniquely woven blend and inherently moisture wicking fiber, Westex<sup>®</sup> DH provides outstanding breathability and optimizes moisture management. IFR Workwear garments made with Westex<sup>®</sup> DH include 1% Anti-Stat fiber.

WHEN IT COMES TO  
**FR SAFETY** | WE ARE  
**ALL IN**

**WESTEX<sup>®</sup>**  
by *Miliken*







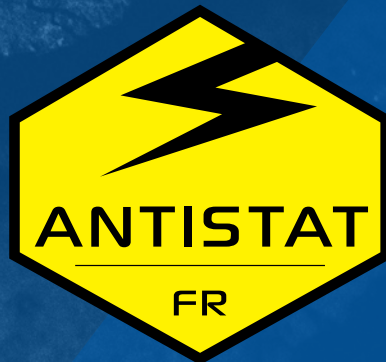

---

# *Improved Antistatic Performance*

---

 **Westex**<sup>®</sup>  
**DH**

DuPont<sup>™</sup>  
**NOMEX**<sup>®</sup> IIIA

# Style 109 - Westex® DH ANTISTAT 6.5 oz Deluxe Coveralls

IFR Workwear added 1% carbon to the Westex® DH fabric to provide the added safety of ANTISTATIC

Trim Featuring 3M™ Scotchlite™ Reflective Material

- 6.5 oz - 48% LENZING™ lyocell, 39% modacrylic, 12% aramid, 1% carbon antistatic
- Material is inherently flame resistant
- Breakaway zipper
- Woven blend provides outstanding breathability
- Optimized moisture management keeps the wearer cooler, drier and more comfortable
- H2S monitor can attach to outside of pocket with strap and elastic fasteners
- Low propensity for piling
- No melt, no drip VELCRO®
- Lowered X striping on back to allow more room for company logo or hooded undergarment\*
- Westex® DH Antistat fabric meets the requirements of: NFPA 2112, NFPA 70E, CGSB 155.20, CSA Z462, ASTM F1506, NFPA 1975, NFPA 1977



STOCK COLOURS:



STOCK SIZES:

38	40	42	44	46	48	50	52	54	56	58
38T	40T	42T	44T	46T	48T	50T	52T	54T	56T	58T

\*Hood provision is added to the new CSA Z96-15 standard.

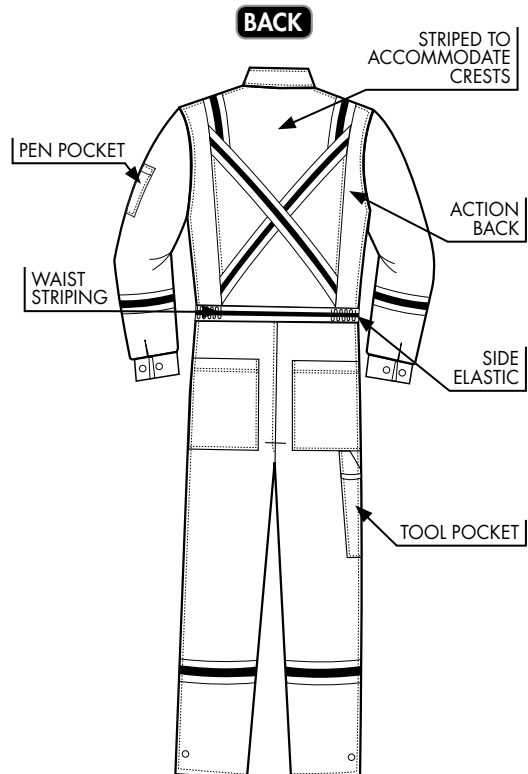
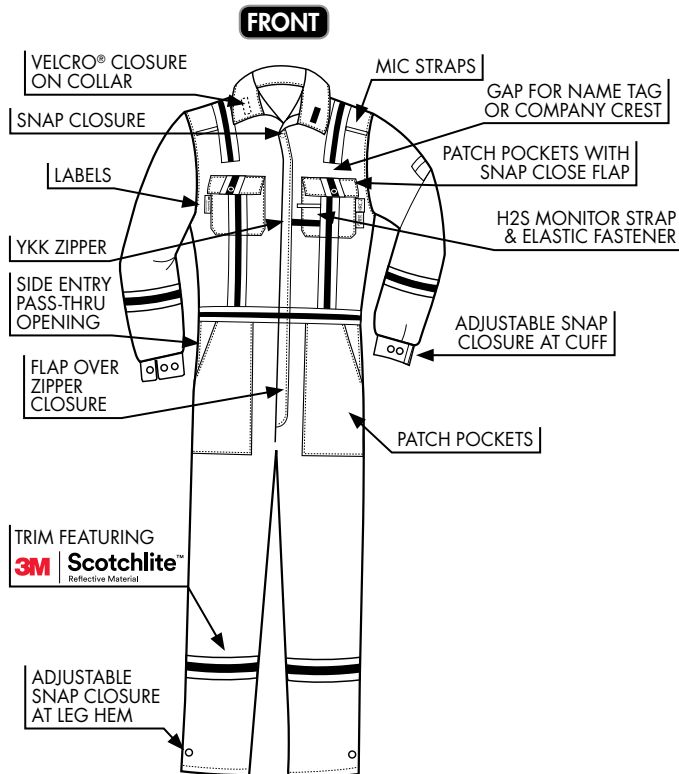

Westex® DH is a registered trademark of Westex® by Milliken® used under license by IFR Workwear Inc. 3M™ and Scotchlite™ are trademarks of 3M™ used under license by IFR Workwear Inc. in Canada.

## Style 122 - Westex® DH ANTISTAT 6.5 oz Bib Pants

IFR Workwear added 1% carbon to the Westex® DH fabric to provide the added safety of ANTISTATIC

Trim Featuring 3M™ Scotchlite™ Reflective Material

- 6.5 oz - 48% LENZING™ lyocell, 39% modacrylic, 12% aramid, 1% carbon antistatic
- Material is inherently flame resistant
- Woven blend provides outstanding breathability
- Optimized moisture management keeps the wearer cooler, drier and more comfortable
- Low propensity for piling
- Westex® DH Antistat fabric meets the requirements of: NFPA 2112, NFPA 70E, CGSB 155.20, CSA Z462, ASTM F1506, NFPA 1975, NFPA 1977



**NEW!**

STOCK COLOURS:



STOCK SIZES:

S	M	L	XL	2XL	3XL	4XL
-	MT	LT	XLT	2XLT	3XLT	4XLT

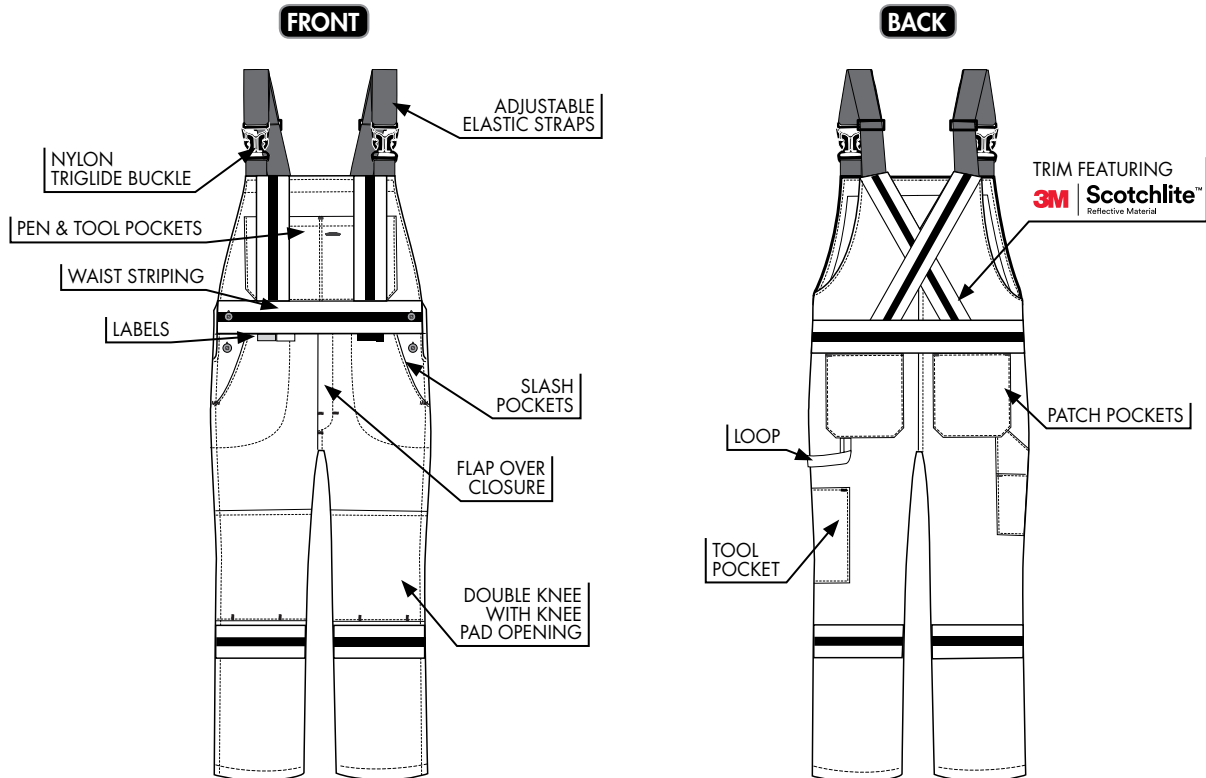

Westex® DH is a registered trademark of Westex® by Milliken® used under license by IFR Workwear Inc. 3M™ and Scotchlite™ are trademarks of 3M™ used under license by IFR Workwear Inc. in Canada.

THE TRUSTED LEADER IN QUALITY FLAME AND ARC RESISTANT WORKWEAR

www.ifrworkwear.ca | 403-347-5480 | info@ifrworkwear.ca



## Style 106 - Nomex® IIIA 6 oz Contractor Coveralls

Trim Featuring 3M™ Scotchlite™ Reflective Material

- 6 oz - 93% Nomex®, 5% Kevlar, and 2% carbon added for improved anti-static performance
- Material is inherently flame resistant
- Breakaway zipper
- No melt, no drip VELCRO®
- Lowered X striping on back to allow room for company logo or hooded undergarment\*\*
- Nomex® fabric meets the requirements of:  
NFPA 2112, CGSB 155.20, NFPA 1977, CGSB 155.22, NFPA 70E, CSA Z462, ASTM F1506



STOCK COLOURS:



STOCK SIZES:

38	40	42	44	46	48	50	52	54	56	58	60-62*
38T	40T	42T	44T	46T	48T	50T	52T	54T	56T	58T	60T-62T*

For royal blue and green, please see style 109.

\*May be a non-stocked item, please call for availability.

\*\*Hood provision is added to the new CSA Z96-15 standard.

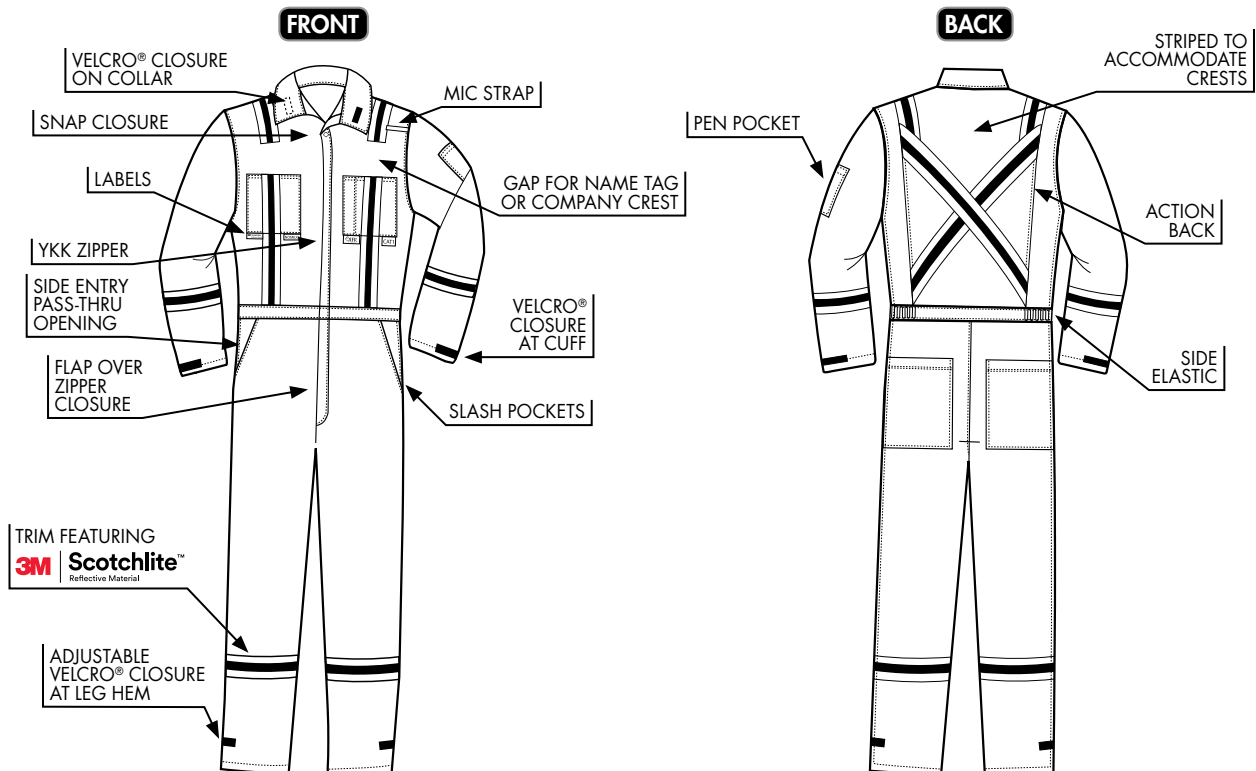

Nomex® is a registered trademark of DuPont™ used under license by IFR Workwear Inc. 3M™ and Scotchlite™ are trademarks of 3M™ used under license by IFR Workwear Inc. in Canada.

# Style 109 - Nomex® IIIA 6 oz Deluxe Coveralls

Trim Featuring 3M™ Scotchlite™ Reflective Material

- 6 oz - 93% Nomex®, 5% Kevlar, and 2% carbon added for improved anti-static performance
- Material is inherently flame resistant
- Breakaway zipper
- H2S monitor can attach to outside of pocket with strap and elastic fasteners
- No melt, no drip VELCRO®
- Lowered X striping on back to allow room for company logo or hooded undergarment\*\*
- Waist striping
- Nomex® fabric meets the requirements of: NFPA 2112, CGSB 155.20, NFPA 1977, CGSB 155.22, NFPA 70E, CSA Z462, ASTM F1506



STOCK COLOURS:



STOCK SIZES:

34*	36	38	40	42	44	46	48	50	52	54	56	58	60-62	64-66*	70*
-	-	38T	40T	42T	44T	46T	48T	50T	52T	54T	56T	58T	60T-62T	64T-66T*	70T*

\*May be a non-stocked item, please call for availability.

\*\*Hood provision is added to the new CSA Z96-15 standard.

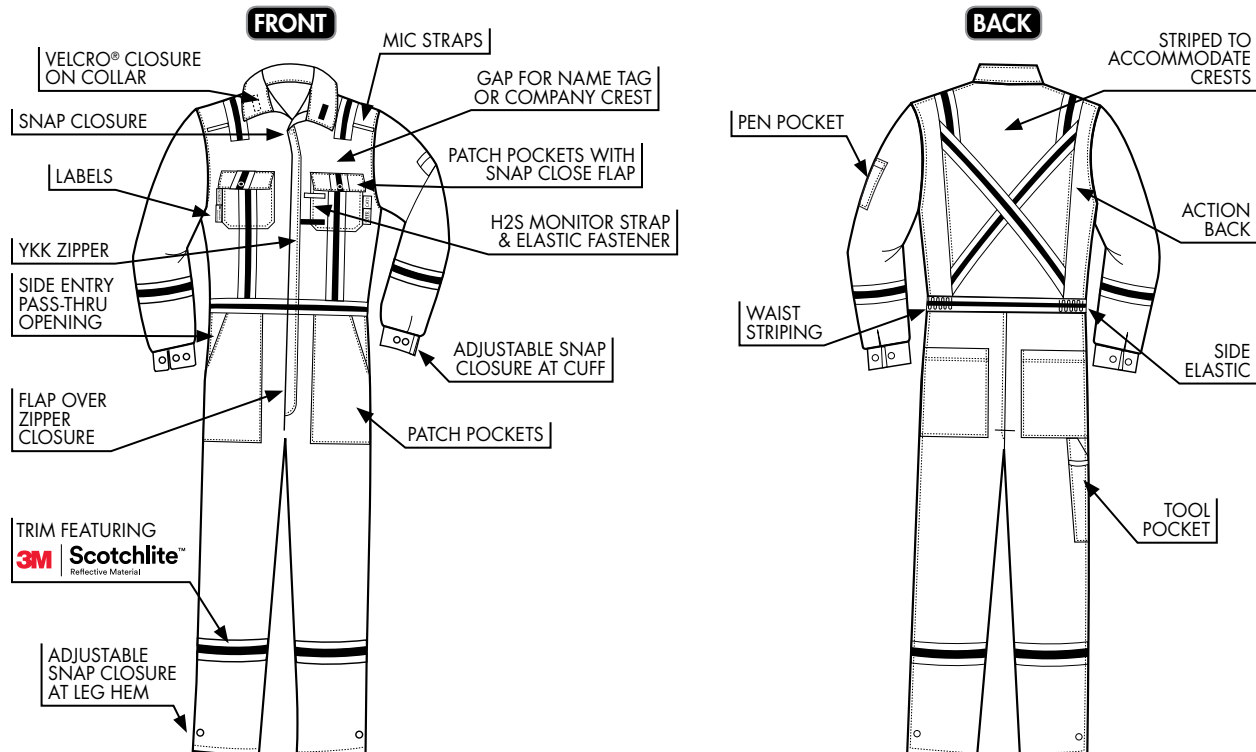

Nomex® is a registered trademark of DuPont™ used under license by IFR Workwear Inc. 3M™ and Scotchlite™ are trademarks of 3M™ used under license by IFR Workwear Inc. in Canada.

THE TRUSTED LEADER IN QUALITY FLAME AND ARC RESISTANT WORKWEAR

www.ifrworkwear.ca | 403-347-5480 | info@ifrworkwear.ca

Nomex® IIIA Summerwear

## Style 122 - Nomex® IIIA 6 oz Bib Pants

Trim Featuring 3M™ Scotchlite™ Reflective Material

- 6 oz - 93% Nomex®, 5% Kevlar, and 2% carbon added for improved anti-static performance
- Material is inherently flame resistant
- Nomex® fabric meets the requirements of:  
NFPA 2112, CGSB 155.20, NFPA 1977, CGSB 155.22,  
NFPA 70E, CSA Z462, ASTM F1506



STOCK COLOURS:



STOCK SIZES:

S	M	L	XL	2XL	3XL
-	MT	LT	XLT	2XLT	3XLT

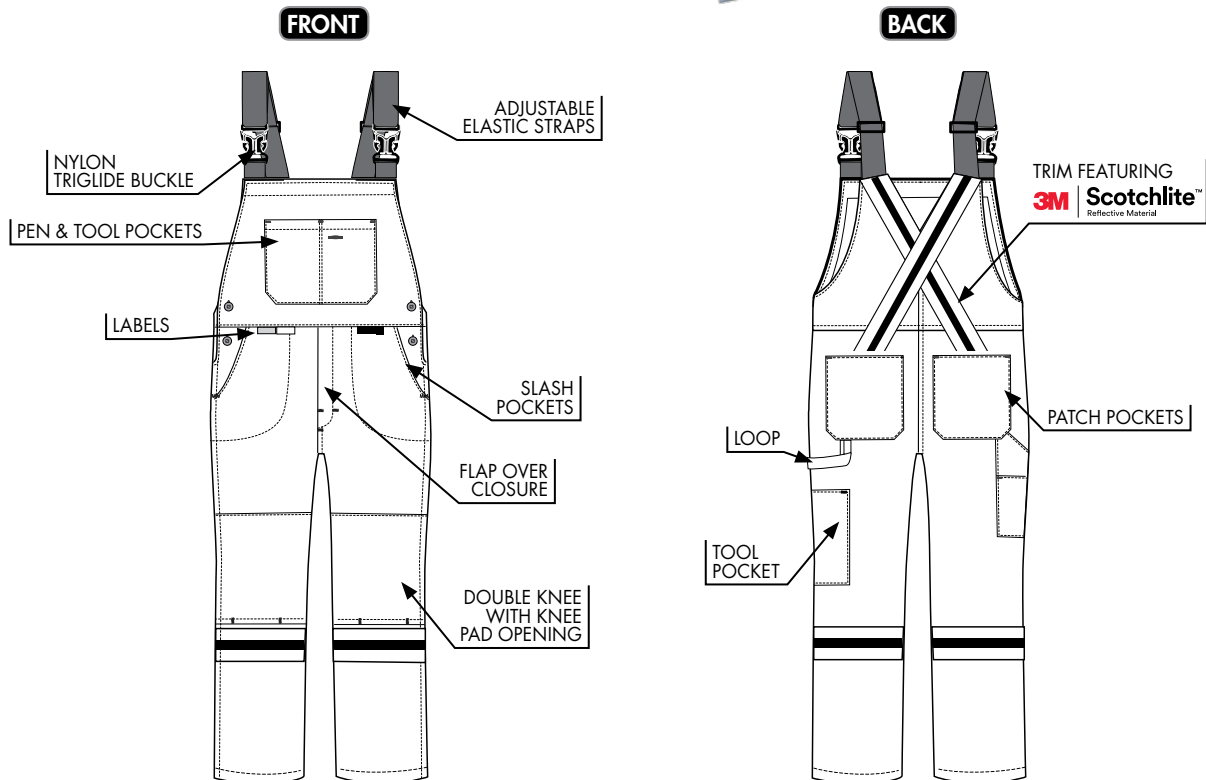

Nomex® is a registered trademark of DuPont™ used under license by IFR Workwear Inc. 3M™ and Scotchlite™ are trademarks of 3M™ used under license by IFR Workwear Inc. in Canada.



# Style 215 - Nomex® IIIA 6 oz Insulated Parka

# Style 225 - Nomex® IIIA 6 oz Insulated Bib Pants

Trim Featuring 3M™ Scotchlite™ Reflective Material

**SHELL:**

- 6 oz - 93% Nomex®, 5% Kevlar, and 2% carbon added for improved anti-static performance
- Material is inherently flame resistant
- Breakaway zipper
- H2S monitor can attach to outside of pocket with strap and elastic fasteners
- No melt, no drip VELCRO®
- Lowered X striping on back to allow room for company logo or hooded undergarment\*\*
- FR fleece lined hand pockets
- Nomex® fabric meets the requirements of: NFPA 2112, CGSB 155.20, NFPA 1977, CGSB 155.22, NFPA 70E, CSA Z462, ASTM F1506

**INSULATION PACKAGE - 12 OZ QUILTED:**

- Wind and vapour barrier
- Modacrylic insulation (flame resistant)
- 88% cotton, 12% high tenacity nylon lining



STOCK COLOURS:



STOCK SIZES:

XS*	S	M	L	XL	2XL	3XL	4XL	5XL*
-	ST*	MT*	LT	XLT	2XLT	3XLT	4XLT	5XLT*

\*May be a non-stocked item, please call for availability.  
\*\*Hood provision is added to the new CSA Z96-15 standard.



*Pairs Perfectly With:*  
**Insulated Parka Hood**  
Style 265 - see page 68

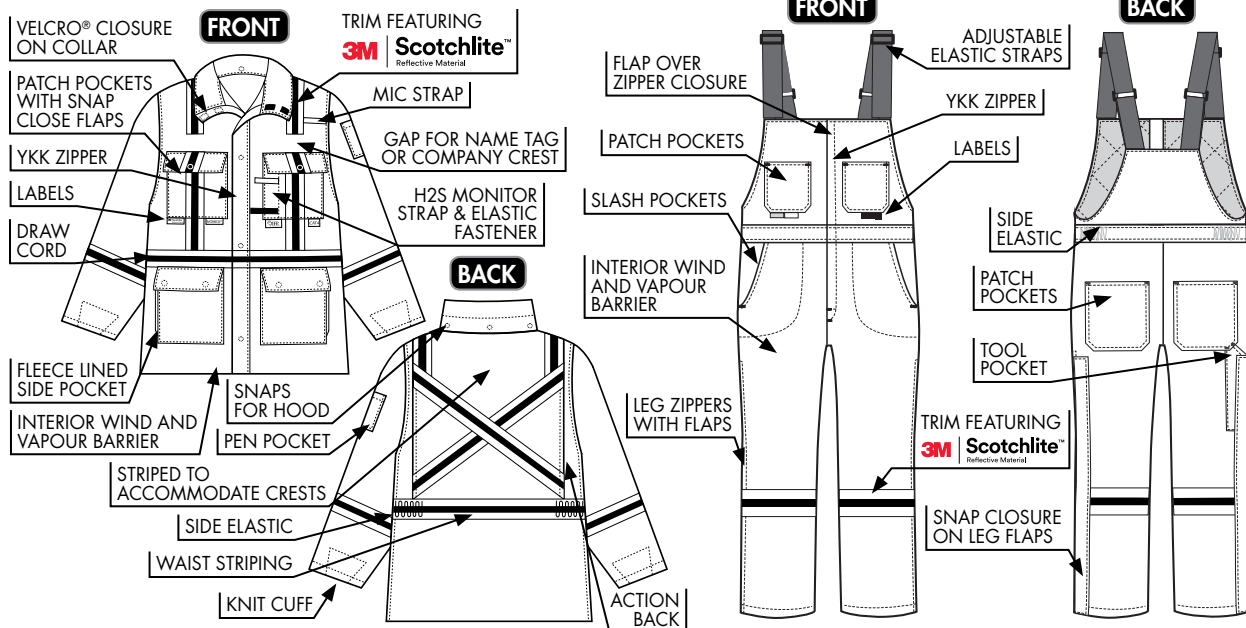

Nomex® is a registered trademark of DuPont™ used under license by IFR Workwear Inc. 3M™ and Scotchlite™ are trademarks of 3M™ used under license by IFR Workwear Inc. in Canada.

THE TRUSTED LEADER IN QUALITY FLAME AND ARC RESISTANT WORKWEAR

www.ifrworkwear.ca | 403-347-5480 | info@ifrworkwear.ca

## Style 216 - Nomex® IIIA 6 oz Insulated Bomber

Trim Featuring 3M™ Scotchlite™ Reflective Material

### SHELL:

- 6 oz - 93% Nomex®, 5% Kevlar, and 2% carbon added for improved anti-static performance
- Material is inherently flame resistant
- Breakaway zipper
- H2S monitor can attach to outside of pocket with strap and elastic fasteners
- No melt, no drip VELCRO®
- Lowered X striping on back to allow room for company logo or hooded undergarment\*
- FR fleece lined hand pockets
- Nomex® fabric meets the requirements of: NFPA 2112, CGSB 155.20, NFPA 1977, CGSB 155.22, NFPA 70E, CSA Z462, ASTM F1506

### INSULATION PACKAGE - 12 OZ QUILTED:

- Wind and vapour barrier
- Modacrylic insulation (flame resistant)
- 88% cotton, 12% high tenacity nylon lining



STOCK COLOURS:



STOCK SIZES:

S	M	L	XL	2XL	3XL	4XL
ST	MT	LT	XLT	2XLT	3XLT	4XLT

\*Hood provision is added to the new CSA Z96-15 standard.

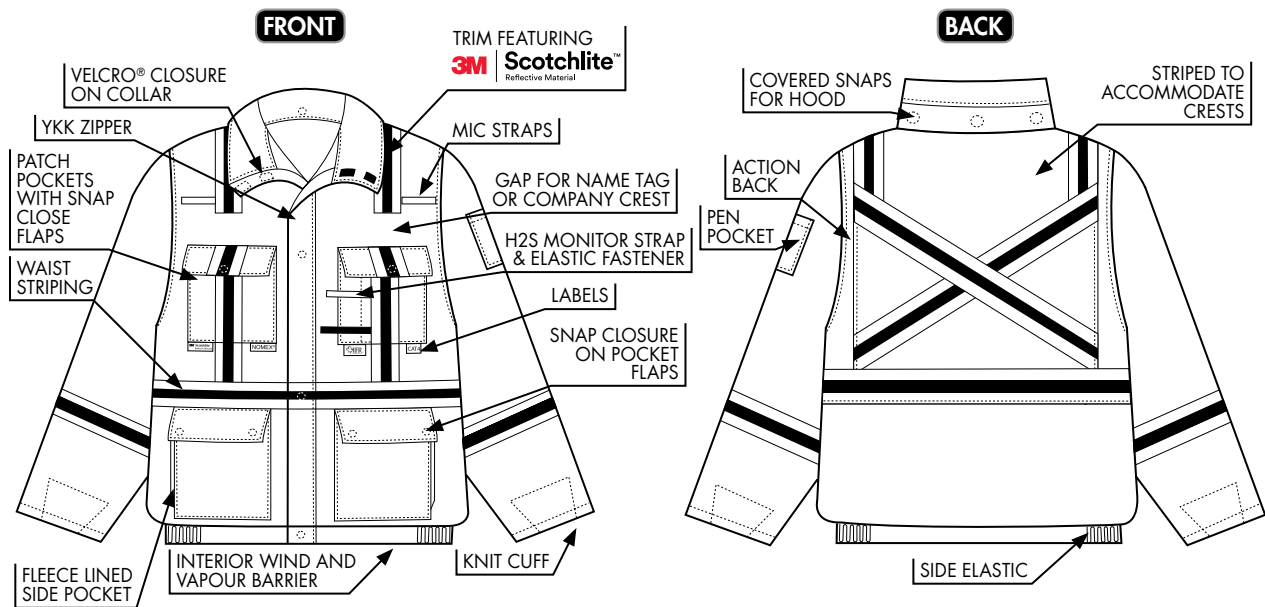

Nomex® is a registered trademark of DuPont™ used under license by IFR Workwear Inc. 3M™ and Scotchlite™ are trademarks of 3M™ used under license by IFR Workwear Inc. in Canada.

## Style 265 - Nomex® IIIA 6 oz Insulated Parka Hood

These hoods are designed to attach to our Nomex® IIIA parkas, and fit over hard hats for flame resistance and maximum protection against the elements. The unique design provides maximum peripheral vision.

**ONE SIZE FITS ALL**



STOCK COLOURS:

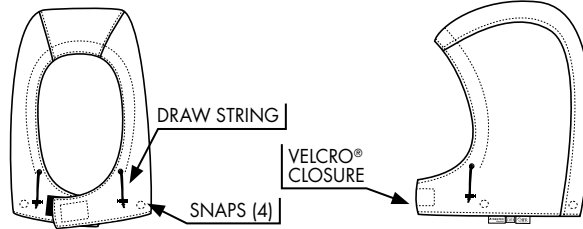

**Attaches to Styles 215, 216**



## Style 275 - Nomex® IIIA 6 oz Insulated Broiler Hard Hat Liner

The broiler hard hat liner is designed to fit under hard hats for flame resistance and maximum protection against the elements. The unique design includes a neck cowl and comes with a removable nose cover designed to prevent safety glasses from fogging see diagram below.

**ONE SIZE FITS ALL**



STOCK COLOURS:

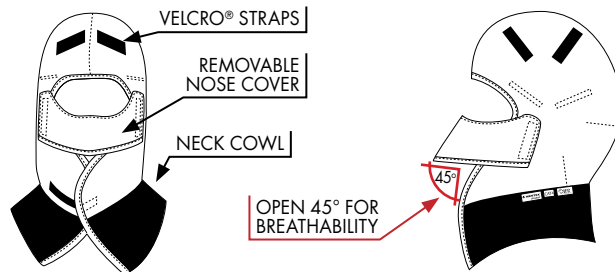

## Style 285 - Nomex® IIIA 6 oz Insulated Hard Hat Liner

These hard hat liners are designed to fit under hard hats for flame resistance and maximum protection against the elements. The unique design provides maximum peripheral vision.

**ONE SIZE FITS ALL**



STOCK COLOURS:

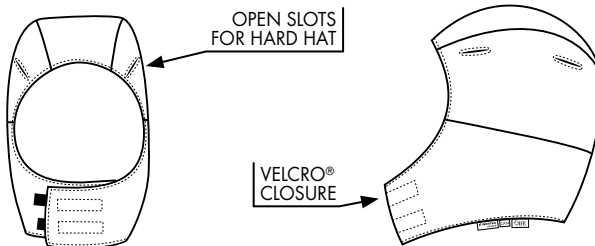

Nomex® is a registered trademark of DuPont™ used under license by IFR Workwear Inc.





## Our Story

Davey Textile Solutions Inc.® is an Alberta based company that has been offering solutions to the textile industry since 1986. The focus of our business is 3M™ Scotchlite™ Reflective Materials and Converted 3M™ Scotchlite™ Trims. We offer our services through a manufacturing facility in Edmonton, AB and a warehouse in Houston, TX, USA. All lines carried by Davey Textile Solutions Inc.® are premier, in line with our mission of “committed to quality and service”.

**Davey Textile Solutions Inc.® is proud to have partnered with IFR Workwear to provide optimum high visibility solutions for their garment programs.**

Our proprietary line of Flame Resistant and Industrial Wash trims, **RT80®**, are proudly manufactured in Edmonton.



## About our Triple Trim

**RT80®** Flame Resistant Reflective Trim is the ultimate solution in the flame resistant protective apparel industry. This trim is the preferred choice for visibility and durability in commercial laundry.

The **RT80®** Series of Flame Resistant Retroreflective Trim continues to exhibit excellent resilience in industrially laundered garments. It is a truly reliable tape that performs and lasts after repeated washings.

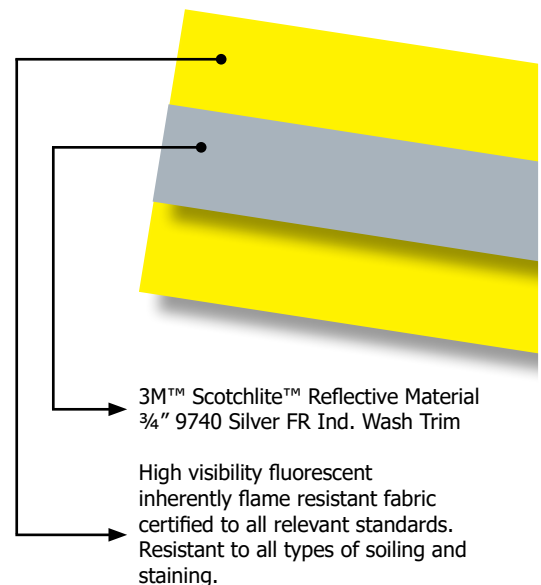

### FLAME RESISTANCE COMPLIANCE:

- CAN/CGSB 155.20-2017
- UL Certified to NFPA 2112-2018 Edition

### HIGH VISIBILITY COMPLIANCE:

- CSA Z96-2015

### CERTIFICATIONS:

- CGSB Certification Program for Flash Fire Workwear
- CAN/CGSB 155.20-2017: Workwear for Protection Against Hydrocarbon Flash Fire
- NFPA 2112 Standard on Flame-Resistant Garments for Protection of Industrial Personnel Against Flash Fire, 2018 Edition

# What is glass bead shearing?

What is the determining factor of a good reflective tape?

The idea behind 3M™ Scotchlite™ Reflective Material is the same science used in a cat's eye. Microscopic glass beads cover the surface of the tape. When light enters the bead, it reflects off the back surface, increasing visibility.

The challenge for most reflective trims is that they lose their reflectivity after industrial washing. This is due to the loss of glass beads during the wash process, otherwise known as glass bead shearing. The backing on some tapes can camouflage this in the day time, but when used at night, it becomes apparent that they are not as effective as they should be.

Our Converted 3M™ Scotchlite™ Reflective Trim, **RT80**®, is manufactured to last for more industrial wash cycles and is more resilient to glass bead shearing than other brands. The reflective properties will remain consistent and visible and ensure safety at all hours for a longer period of time.

**CANADA**  
10505 169 St.  
Edmonton, AB  
T5P 4Y7  
1-888-484-4888

**UNITED STATES**  
12554 HWY 3, Suite B-210  
Houston, TX  
77598  
1-281-724-0956





## Style 240 - UltraSoft® 9 oz FR Insulated Vest

*Trim Featuring 3M™ Scotchlite™ Reflective Material*

### SHELL:

- 9 oz - 88% cotton, 12% high tenacity nylon from Westex®
- Engineered for flame resistance and guaranteed for the life of the garment
- Lowered X striping on back to allow more room for company logo or hooded undergarment
- Multi-purpose protection from electric arc, flash fire, molten ferrous metal and welding exposure

### INSULATION PACKAGE - 12 OZ QUILTED:

- Wind and vapour barrier
- Modacrylic insulation (flame resistant)
- 88% cotton, 12% high tenacity nylon lining

*More information, technical specifications and sizes on page 55.*



## Style 1250 - **AVENGER** 7 oz FR Surveyor Vest

*Trim Featuring 3M™ Scotchlite™ Reflective Material*

Style 1250 gives you everything you need at your fingertips. Made from 7 oz Avenger fabric, this material is flame resistant and comfortable to wear. All trim including VELCRO® and webbing are also flame resistant.

A multitude of pockets are situated where you need them, including four inside pockets.

- 7 oz - FR 88% cotton, 12% nylon twill weave, preshrunk fabric
- Flame resistant and guaranteed for the life of the garment
- Multi-purpose protection from electric arc and flash fire
- NAFTA - made with North American fabric and components
- CSA Z96-15 compliant

*More information, technical specifications and sizes on page 36.*



3M™ and Scotchlite™ are trademarks of 3M™ used under license by IFR Workwear Inc. in Canada.



## Style 1130 - UltraSoft® 7 oz FR Surveyor Vest

4" Trim Featuring 2" 3M™ Scotchlite™ Reflective Material

Designed with a multitude of pockets that are situated where you need them; including three inside pockets with VELCRO® closures, cell phone/GPS pockets, pen and tool pockets, a reinforced side map pocket with zipper closure, and grommets installed in the two lower front pockets for convenience to pull ribbon/tape through.

Specially designed for surveying, but suitable for anywhere flame resistance and high visibility is needed, including, but not limited to: oil and gas, utilities, railroad, construction/traffic.

- 7 oz - 88% cotton, 12% high tenacity nylon from Westex®
- Multi-purpose protection from electric arc, flash fire and molten ferrous metal

More information, technical specifications and sizes on page 25.



## Style 1715 - UltraSoft® 7 oz FR Yard Vest

Featuring 2" 3M™ Scotchlite™ Reflective Heat Transfer Industrial Material

- 7 oz - 88% cotton, 12% high tenacity nylon from Westex®
- Engineered for flame resistance and guaranteed for the life of the garment
- 50% extended garment wear life over 100% cotton
- Soft feel of cotton comfort
- No melt, no drip VELCRO®
- Multi-purpose protection from electric arc, flash fire and molten ferrous metal

More information, technical specifications and sizes on page 26.



5 Point Tear-Away

Westex UltraSoft® is a registered trademark of Westex® by Milliken® used under license by IFR Workwear Inc. 3M™ and Scotchlite™ are trademarks of 3M™ used under license by IFR Workwear Inc. in Canada.

THE TRUSTED LEADER IN QUALITY FLAME AND ARC RESISTANT WORKWEAR

www.ifrworkwear.ca | 403-347-5480 | info@ifrworkwear.ca

## Style 1715 - Mesh Yard Vest

Featuring 2" 3M™ Scotchlite™ Reflective Trim

- 5-Point tear-away system that allows the vest to "tear-away" at 5 points in case of emergencies
- Made with "Hi-Viz" 100% polyester mesh
- Breathable and ANSI approved
- Expandable radio holster

More information, technical specifications and sizes on page 27.



## Style 1705 - Locomotive Engineer O.C.U. Vest

Featuring 3M™ Scotchlite™ Reflective Trim

- The latest evolution in operator control unit carrying systems
- Multi position 4 point operator control unit attachments
- Ergonomic design - adjustable aluminum bars/supports to distribute weight across the torso
- Full tear away (4 point)
- Field changeable clips on vests
- 3 VELCRO® strap locations for available attachments

STOCK COLOURS:



STOCK SIZES:

S	M	L	XL	2XL	3XL
---	---	---	----	-----	-----

## Style 1710 - Locomotive Engineer O.C.U. Vest

Featuring 2" 3M™ Scotchlite™ Reflective Material

- The latest evolution in operator control unit carrying systems
- Multi position 4 point operator control unit attachments
- Ergonomic design - adjustable aluminum bars/supports to distribute weight across the torso
- Full tear away (4 point)
- Field changeable clips on vests

STOCK COLOURS:

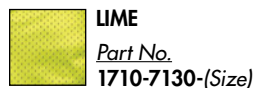

STOCK SIZES:

S	M	L	XL	2XL	3XL
---	---	---	----	-----	-----

3M™ and Scotchlite™ are trademarks of 3M™ used under license by IFR Workwear Inc. in Canada.

## Style 1706/1712 - Insert Panel

Featuring 3M™ Scotchlite™ Reflective Trim

To expand the vest sides and make it larger.

- Available in 10" and 18"
- Reinforced body for durability
- 3M™ Scotchlite™ reflective material for high visibility



STOCK COLOURS:

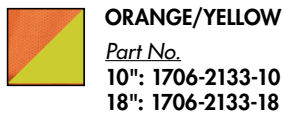
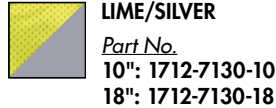
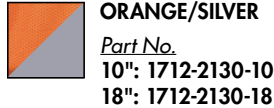

## Style 1713-2130 - Switchlist Pocket

Featuring 3M™ Scotchlite™ Reflective Trim

The switchlist pocket can attach to our railroad vests or any item that fits through the belt loop at the back of the attachment.

- Dimensions: 6" H x 8" W
- VELCRO® flap closure
- Reinforced body for durability
- Extra large, wide belt loop backing for sturdy attachment to your belt
- 3M™ Scotchlite™ reflective material for high visibility



3M™ and Scotchlite™ are trademarks of 3M™ used under license by IFR Workwear Inc. in Canada.









Soft, stretch,  
flame resistant  
base layers for  
all day comfort



## Style 750 - *Women's* IFR BaseWear Top

## Style 760 - *Women's* IFR BaseWear Bottom

- 6.75 oz interlock, 45% modacrylic, 45% rayon, 10% para-aramid
- Inherently flame resistant and guaranteed for the life of the garment
- Medium weight, form fitting stretch comfort, very soft fabric with smooth flatlock seams
- Wear under FR garments for increased protection
- IFR BaseWear fabric meets the requirements of: NFPA 2112, NFPA 70E



STOCK COLOURS:



STOCK SIZES:

XS	S	M	L	XL	2XL	3XL
----	---	---	---	----	-----	-----

**NEW!**



**FRONT**

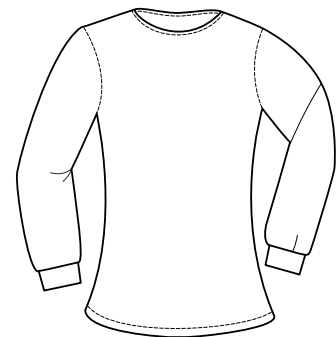
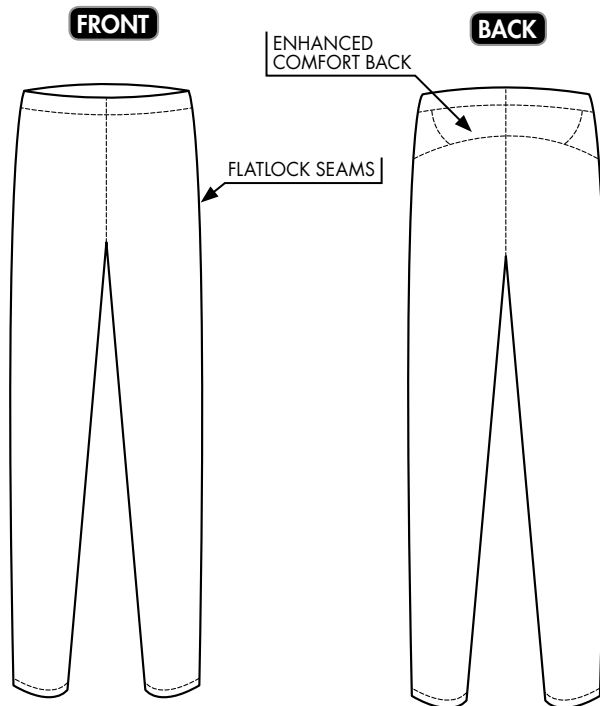

**BACK**

FLATLOCK SEAMS

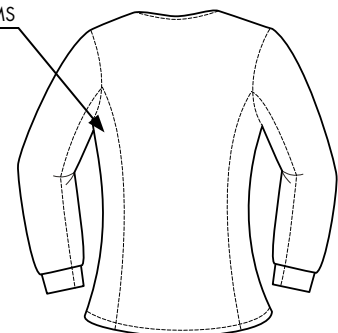



## Style 700 - Men's IFR BaseWear Top

## Style 710 - Men's IFR BaseWear Bottom

- 6.75 oz interlock, 45% modacrylic, 45% rayon, 10% para-aramid
- Inherently flame resistant and guaranteed for the life of the garment
- Medium weight, form fitting stretch comfort, very soft fabric with smooth flatlock seams
- Wear under FR garments for increased protection
- IFR BaseWear fabric meets the requirements of: NFPA 2112, NFPA 70E



STOCK COLOURS:



STOCK SIZES:

S	M	L	XL	2XL	3XL
---	---	---	----	-----	-----



**NEW!**

**FRONT**

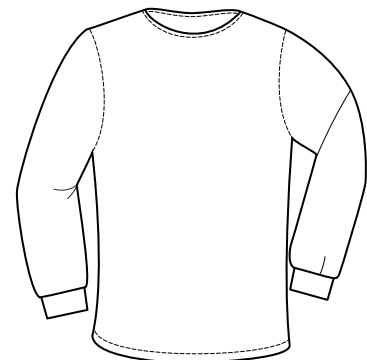
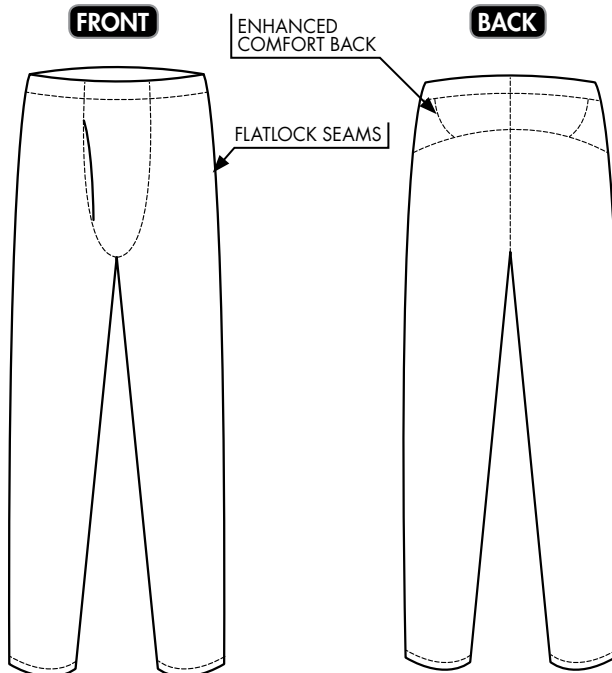

**BACK**

FLATLOCK SEAMS

CUFF

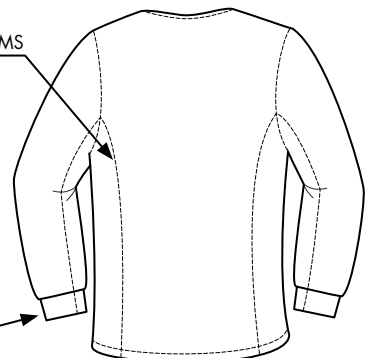

## Style 324 - Fleece Full Zip Jacket

- 14 oz - 55% modacrylic, 45% cotton
- Fabric is inherently flame resistant
- Full zipper
- Slash pockets
- This fleece fabric meets the requirements of:  
NFPA 2112, NFPA 70E, CSA Z462



STOCK COLOURS:

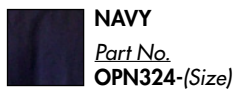

STOCK SIZES:

S	M	L	XL	2XL	3XL	4XL
-	-	LT	XLT	2XLT	3XLT	4XLT

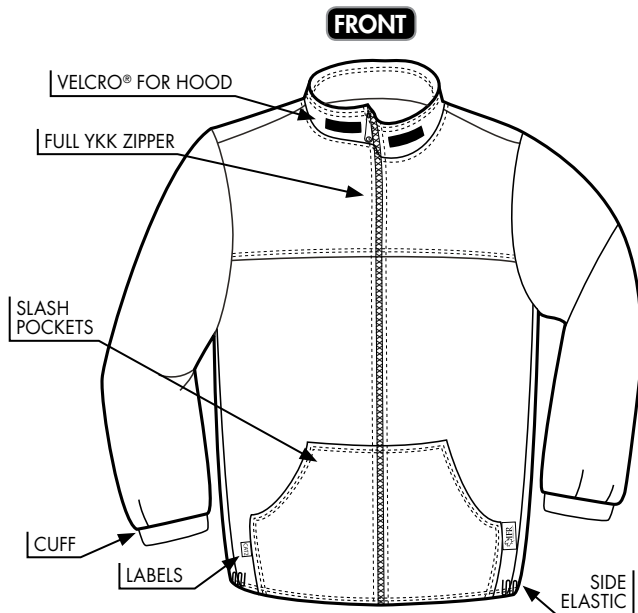

## Style 324 - Striped Fleece Full Zip Jacket

Trim Featuring 3M™ Scotchlite™ Reflective Material

- 14 oz - 55% modacrylic, 45% cotton
- Fabric is inherently flame resistant
- Full zipper
- Slash pockets
- Lowered X striping on back to allow room for company logo or hooded undergarment\*
- This fleece fabric meets the requirements of: NFPA 2112, NFPA 70E, CSA Z462



STOCK COLOURS:



STOCK SIZES:

S	M	L	XL	2XL	3XL	4XL
-	-	LT	XLT	2XLT	3XLT	-

\*Hood provision is added to the new CSA Z96-15 standard.

For **Women's Fleece**, see style 474 on page 8.

For **Striped Hi-Vis Orange**, see style 329 on page 20.

Pairs Perfectly With:

**Fleece Hood**

Style 364 - see page 83

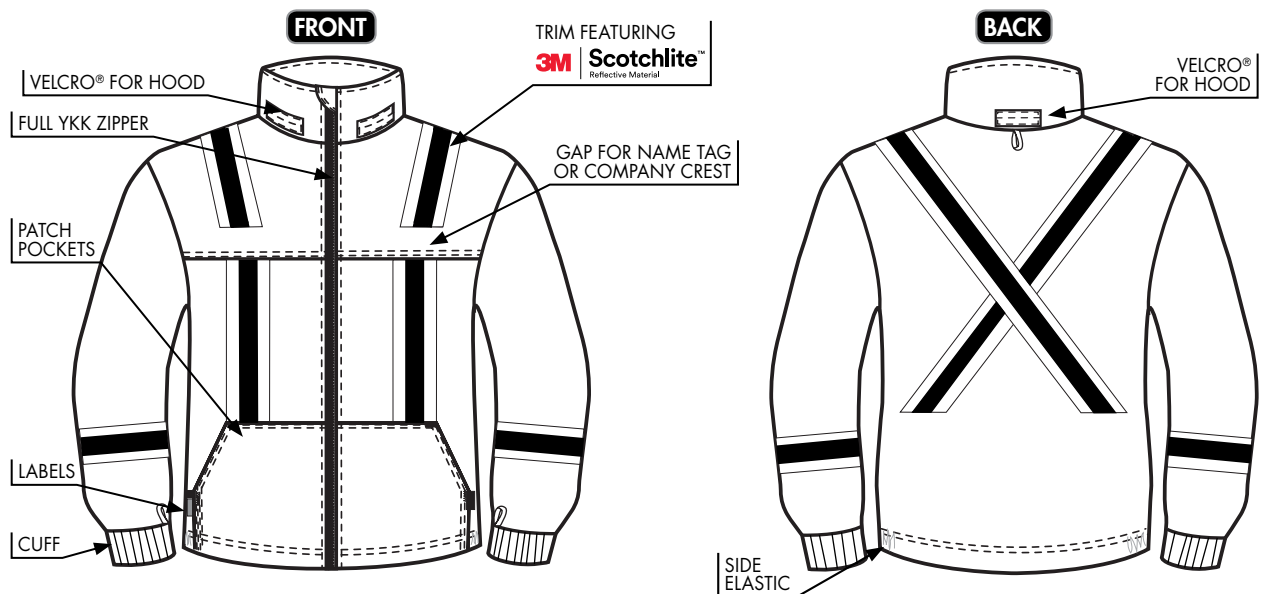

3M™ and Scotchlite™ are trademarks of 3M™ used under license by IFR Workwear Inc. in Canada.



## Style 325 - Fleece Pullover

- 14 oz - 55% modacrylic, 45% cotton
- Fabric is inherently flame resistant
- 8" zipper
- Kangaroo pocket
- This fleece fabric meets the requirements of:  
NFPA 2112, NFPA 70E, CSA Z462



STOCK COLOURS:



STOCK SIZES:

S	M	L	XL	2XL	3XL	4XL
---	---	---	----	-----	-----	-----

*Pairs Perfectly With:*

**Fleece Hood**

Style 364 - see page 83

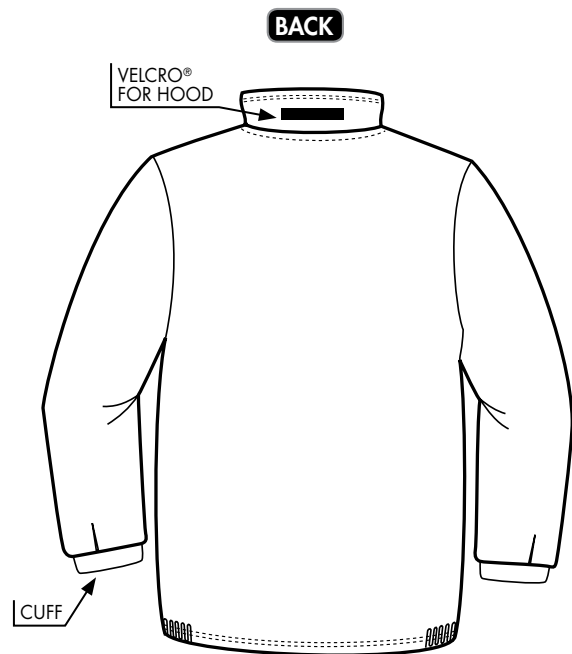
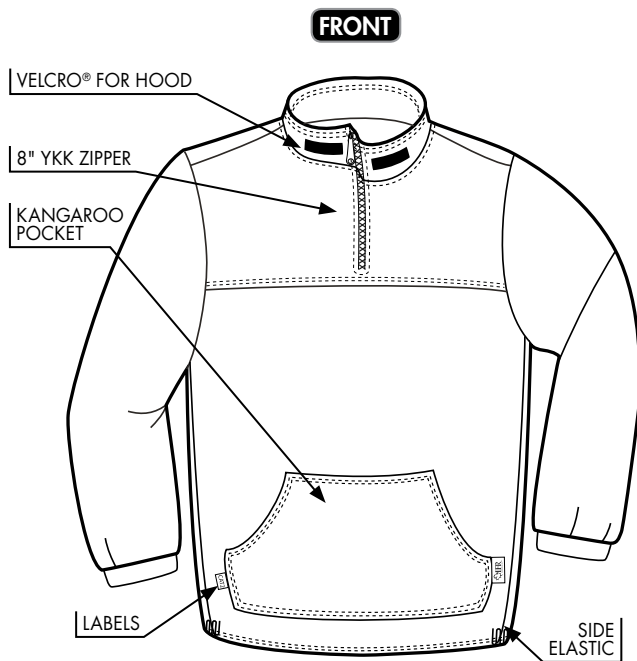

## Style 335 - Reliant® Rib Knit Pullover

- 9.5 oz - 55% modacrylic, 45% cotton
- Inherently flame resistant
- 8" Nomex® VISLON® zipper with inside placket
- Reliant® fabric meets the requirements of: ASTM F1506, CSA Z462, NFPA 2112, NFPA 70E



**EXCLUSIVE TO IFR!**

STOCK COLOURS:



STOCK SIZES:

S	M	L	XL	2XL	3XL
---	---	---	----	-----	-----

Made in the USA 

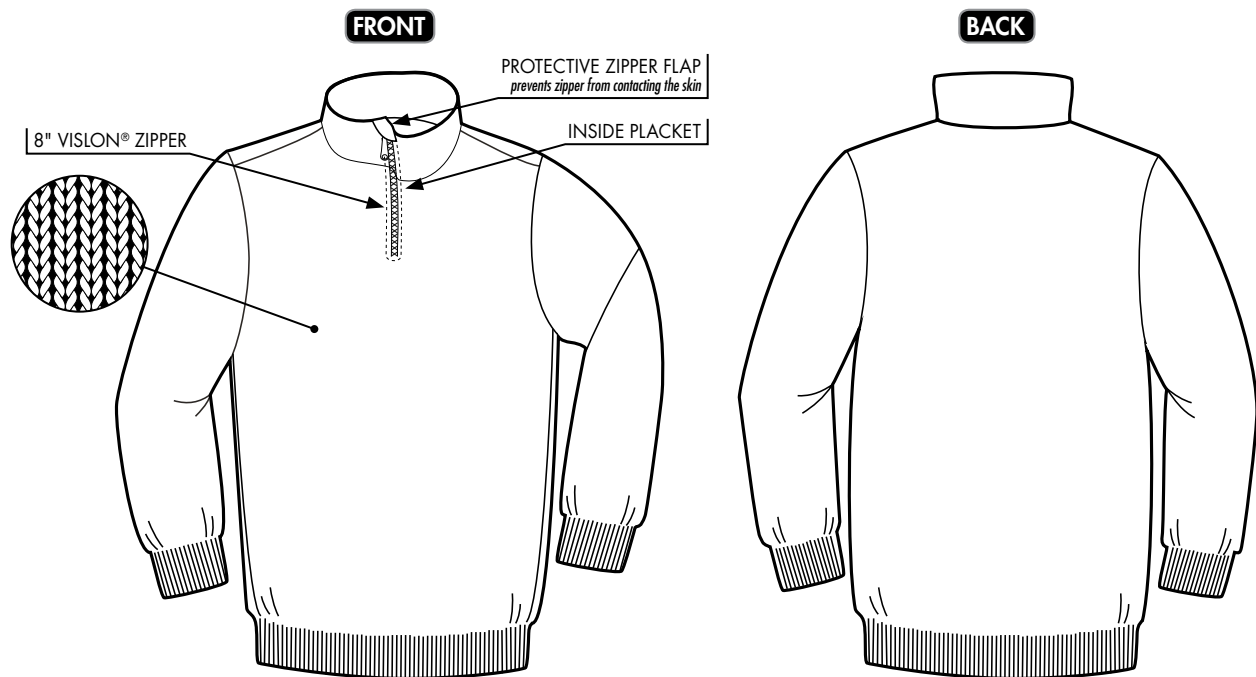

Reliant® is a registered trademark of Innovative Textiles Inc. used under licence by IFR Workwear Inc.

THE TRUSTED LEADER IN QUALITY FLAME AND ARC RESISTANT WORKWEAR

www.ifrworkwear.ca | 403-347-5480 | info@ifrworkwear.ca

## Style 364 - Fleece Hood

- 55% modacrylic, 45% cotton
- Fabric is inherently flame resistant
- VELCRO® closure to attach to fleece jackets

**ONE SIZE FITS ALL**



STOCK COLOURS:



**NAVY**  
Part No.  
OPN364



**ORANGE**  
Part No.  
OPO364



**FRONT**

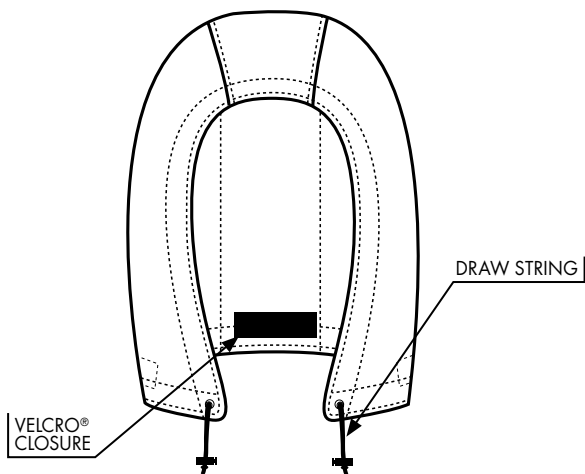

**SIDE**

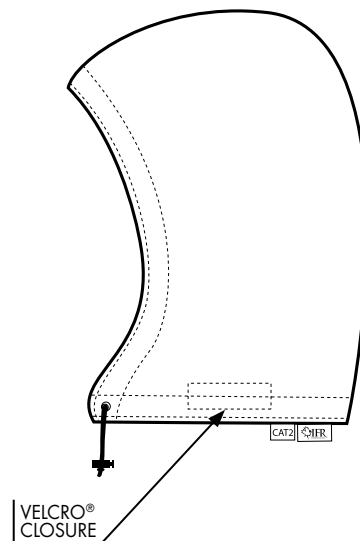





# SAMPLE & RETURN POLICY

## SAMPLES & SIZING GARMENTS

- « All samples or sizing garments will be invoiced to the customer, but may be returned according to the guidelines detailed under our return policy.
- « Returned samples or sizing garments must be in original condition for full credit.
- « Specially designed custom samples are considered a final sale.



## RETURNS

- « All return requests must be submitted via email with original PO #, invoice #, or sales order # to [rma@ifrworkwear.ca](mailto:rma@ifrworkwear.ca), **within 30 days of purchase date**, to obtain a Return Merchandise Authorization (RMA) number and form.
- « Goods that have been worn, soiled or altered in any way are not returnable.
- « Special-order, direct embroidered, non-stock items are not returnable.
- « Returned goods must be shipped freight prepaid, and must include a copy of the invoice or packing slip and the completed RMA form.
- « Returned goods must be in their original condition.
- « Returns will not be accepted without a pre-approved RMA number.



---

THE TRUSTED LEADER IN QUALITY FLAME AND ARC RESISTANT WORKWEAR

99 Quinn Avenue, Red Deer, Alberta T4P 0R7 Canada

PHONE: 403-347-5480 | FAX: 403-347-0070 | TOLL FREE: 1-888-550-6006 | EMAIL: [info@ifrworkwear.ca](mailto:info@ifrworkwear.ca)

[www.ifrworkwear.ca](http://www.ifrworkwear.ca)

## Style J62 - Nomex® IIIA 7" Knit Rib Neck Warmer



- 93% Nomex®, 6% Kevlar, 1% Anti-static
- Material is inherently flame resistant
- Double layer construction
- Tight knit
- Nice soft feel
- Nomex® fabric meets the following standards: ASTM F1506, NFPA 70E

STOCK COLOURS:



**ONE SIZE FITS ALL**

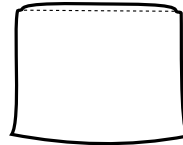

## Style J63 - Nomex® IIIA Knit Rib Folded Toque



- 93% Nomex®, 6% Kevlar, 1% Anti-static
- Material is inherently flame resistant
- Double layer construction
- Tight knit
- Nice soft feel
- Nomex® fabric meets the following standards: ASTM F1506, NFPA 70E

STOCK COLOURS:

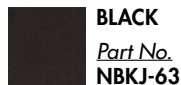

**ONE SIZE FITS ALL**

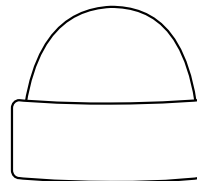

## Style J64 - Nomex® IIIA Knit Rib Beanie



- 93% Nomex®, 6% Kevlar, 1% Anti-static
- Material is inherently flame resistant
- Double layer construction
- Tight knit
- Nice soft feel
- Nomex® fabric meets the following standards: ASTM F1506, NFPA 70E

STOCK COLOURS:

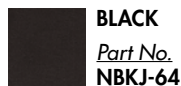

**ONE SIZE FITS ALL**

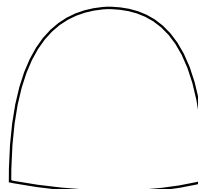

## Style J67 - Nomex® IIIA Knit Rib Balaclava



- 93% Nomex®, 6% Kevlar, 1% Anti-static
- Material is inherently flame resistant
- Double layer construction
- Tight knit
- Nice soft feel
- Nomex® fabric meets the following standards: ASTM F1506, NFPA 70E

STOCK COLOURS:

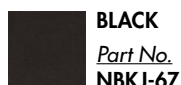

**ONE SIZE FITS ALL**

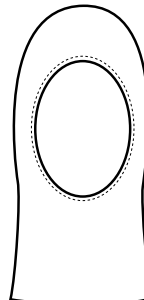

Nomex® is a registered trademark of DuPont™ used under license by IFR Workwear Inc.

## Style J56 - Kermel® 7" Knit Rib Neck Warmer



- 49.5% Kermel®, 49.5% FR rayon, 1% Anti-static
- Material is inherently flame resistant
- Double layer construction
- Tight knit
- Nice soft feel
- Kermel® fabric meets the following standards: ASTM F1506, NFPA 70E

STOCK COLOURS:  
 **BLACK**  
*Part No.*  
**KBJ-56**

**ONE SIZE FITS ALL**

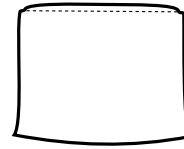

## Style J57 - Kermel® Knit Rib Folded Toque



- 49.5% Kermel®, 49.5% FR rayon, 1% Anti-static
- Material is inherently flame resistant
- Double layer construction
- Tight knit
- Nice soft feel
- Kermel® fabric meets the following standards: ASTM F1506, NFPA 70E

STOCK COLOURS:  
 **BLACK**  
*Part No.*  
**KBJ-57**

**ONE SIZE FITS ALL**

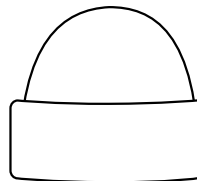

## Style J58 - Kermel® Knit Rib Balaclava



- 49.5% Kermel®, 49.5% FR rayon, 1% Anti-static
- Material is inherently flame resistant
- Double layer construction
- Tight knit
- Nice soft feel
- Kermel® fabric meets the following standards: ASTM F1506, NFPA 70E

STOCK COLOURS:  
 **BLACK**  
*Part No.*  
**KBJ-58**

**ONE SIZE FITS ALL**

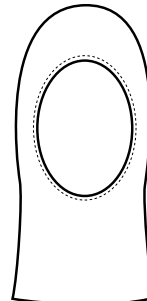

## Style J59 - Kermel® Knit Rib Beanie



- 49.5% Kermel®, 49.5% FR rayon, 1% Anti-static
- Material is inherently flame resistant
- Double layer construction
- Tight knit
- Nice soft feel
- Kermel® fabric meets the following standards: ASTM F1506, NFPA 70E

STOCK COLOURS:  
 **BLACK**  
*Part No.*  
**KBJ-59**

**ONE SIZE FITS ALL**

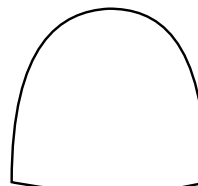

Kermel® is a registered trademark of GlenGuard® used under license by IFR Workwear Inc.





WELD  
ARMOR



The logo is centered on a silver metal plate with a brushed texture and several screws around the perimeter. The text "WELD ARMOR" is in a bold, sans-serif font, with "WELD" in black and "ARMOR" in brown. Below it, "BY" is in a smaller black font, followed by a red maple leaf icon and "IFR" in a black serif font.

**WELD ARMOR**<sup>TM</sup>  
BY  **IFR**





# Style 4330 - WeldArmor™ TITANIUM Jacket

Trim Featuring 3M™ Scotchlite™ Reflective Material

- FR hooded jacket made from midweight fleece
- 55% modacrylic, 45% cotton
- Fabric is inherently flame resistant
- Premium grade cowhide raglan leather sleeves for increased protection and longevity
- FR VISLON® zipper with protective cover flap
- Sewn with high tenacity FR thread - double stitched and bar-tacked at all stress points and critical wear areas
- Detachable hood



©Canadian Design Patent No.150088



**DUAL SLEEVE**  
Independent sleeves work together to provide increased **PROTECTION, MOBILITY & COMFORT**

STOCK COLOURS:

**BLACK/BLACK**  
Part No.  
**WSBK4330-(Size)**

STOCK SIZES:

S	M	L	XL	2XL	3XL
---	---	---	----	-----	-----

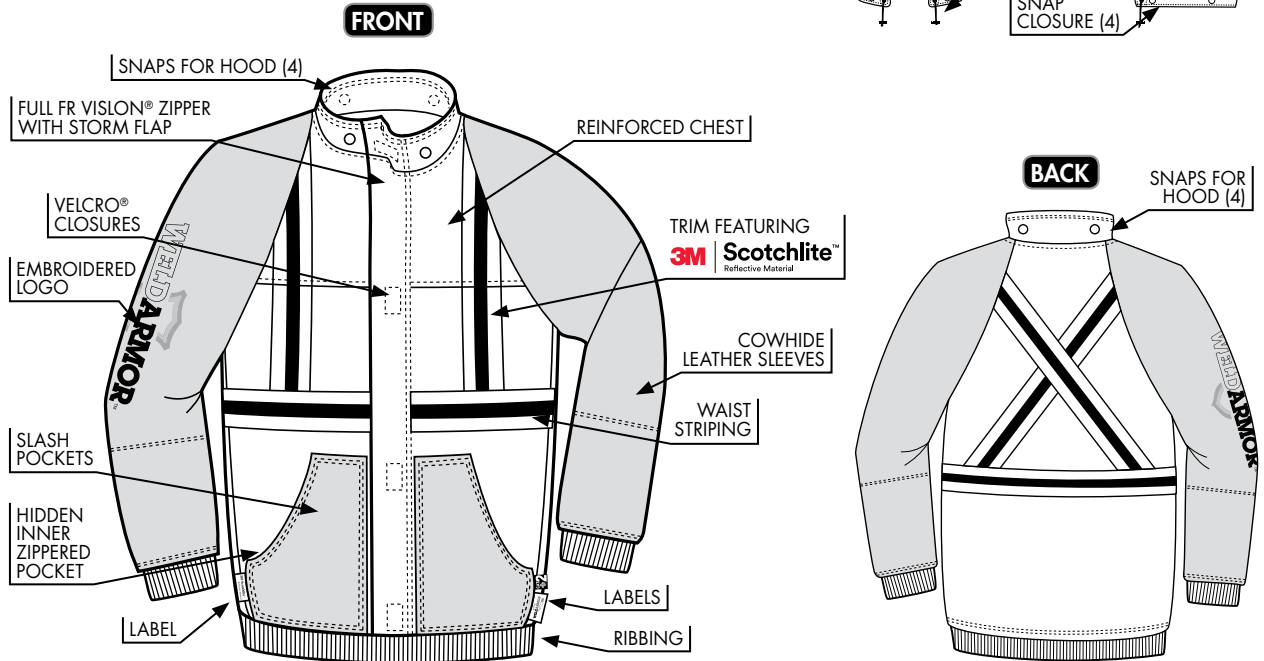
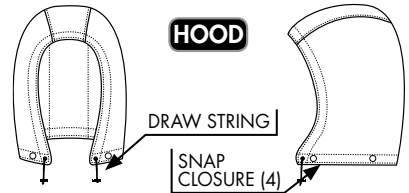

3M™ and Scotchlite™ are trademarks of 3M™ used under license by IFR Workwear Inc. in Canada.



# Style 4331 - WeldArmor™ PIPELINER Jacket

Trim Featuring 3M™ Scotchlite™ Reflective Material

- FR hooded jacket made from midweight fleece
- 55% modacrylic, 45% cotton
- Fabric is inherently flame resistant
- Premium grade cowhide leather sleeves, front chest and sides of hood for increased protection and longevity.
- Leather outer sleeves are independent from inner fleece sleeves to provide comfort fit
- FR VISLON® zipper with protective cover flap
- Sewn with a high tenacity FR thread - double stitched and bar-tacked at all stress points and critical wear areas
- Detachable hood



©Canadian Design Patent No.150088



**DUAL SLEEVE**  
Independent sleeves work together to provide increased PROTECTION, MOBILITY & COMFORT

STOCK COLOURS:

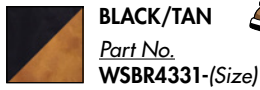

STOCK SIZES:

S	M	L	XL	2XL	3XL
---	---	---	----	-----	-----

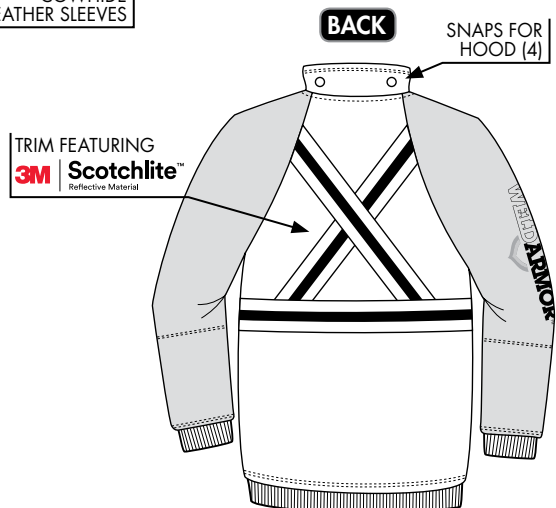
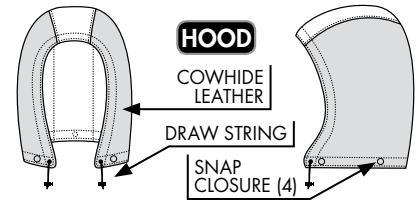
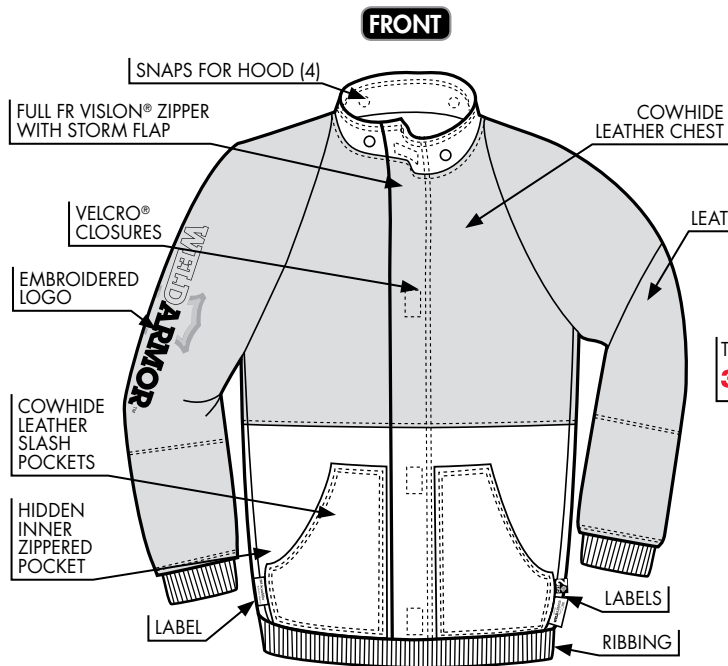

3M™ and Scotchlite™ are trademarks of 3M™ used under license by IFR Workwear Inc. in Canada.

THE TRUSTED LEADER IN QUALITY FLAME AND ARC RESISTANT WORKWEAR

www.weldarmor.ca | 403-347-5480 | info@ifrworkwear.ca

## Style 1750 - Leather Belt

Our quality leather belt is a perfect accessory to our pant styles 671, 3610, 611 and 612.

- Made with durable leather
- Leather is inherently flame resistant
- Fastens with FR VELCRO®, easily adjustable, tear-away style
- Absence of buckles prevents electrical arcing, static shock, snagging, and other potential workplace hazards in various industries such as electrical and oilfield
- Airport security compliant

STOCK COLOURS:

- BLACK**
- Part No. 1750-30 [SIZE]*
- 1750-3034 (fits waist size 32-34)
  - 1750-3038 (fits waist size 36-38)
  - 1750-3042 (fits waist size 40-42)
  - 1750-3046 (fits waist size 44-46)
  - 1750-3050 (fits waist size 48-50)



STOCK SIZES:

32-34	36-38	40-42	44-46	48-50
-------	-------	-------	-------	-------

*Pairs Perfectly:*

- Style 671 - Women's Cargo Pants
- Style 3610 - Avenger Duck Pants
- Style 611 - UltraSoft® Cargo Pants
- Style 612 - UltraSoft® Cargo Pants

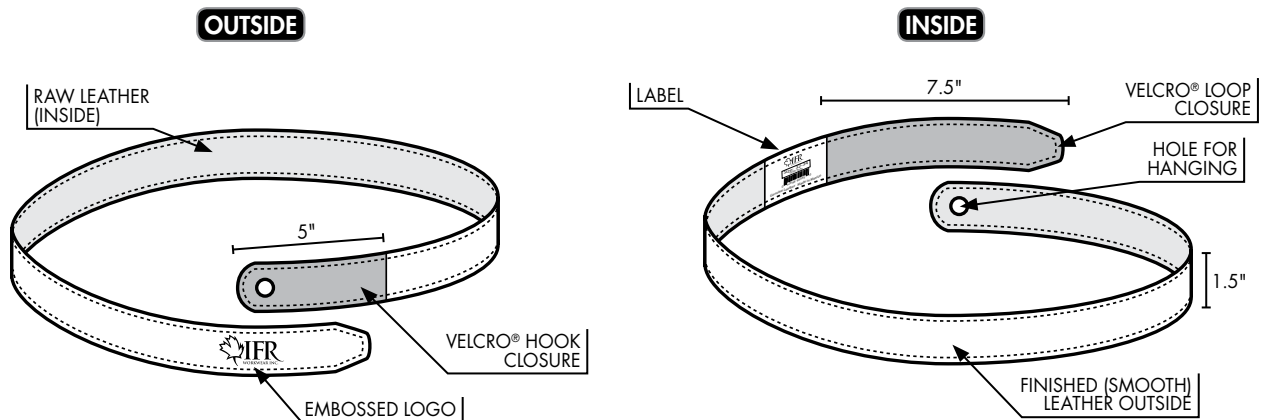

## Style 3110 - PPE Duffle Bag (3 compartments)

Our extremely tough heavy duty duffle bags get the job done.

- Made with 18 oz woven polyester scrim coated with PVC
- Resilient to temperatures down to -40°C
- Ultraviolet resistant
- Mildew and rot resistant
- Easily wipes clean
- Heavy duty webbing used throughout
- 1 large compartment with 2 side compartments
- Heavy duty zippers
- 25" L x 12" H x 14" W (69 litres)

STOCK COLOURS:



## Style 1711 - Belt Style Radio Holster - Universal Fit

*Trim Featuring 3M™ Scotchlite™ Reflective Material*

The radio holster fits most sizes of radios. This makes the radio holster attachment an absolute must for your radio. The radio holster can attach to our railroad vests or any item that fits through the belt loop at the back of the attachment.

- Fully adjustable VELCRO® closures for tight fit on most radios
- Reinforced body for durability
- Extra large, wide belt loop backing for sturdy attachment to your belt
- VELCRO® backing to attach to our railroad vests
- 3M™ Scotchlite™ reflective material for high visibility on extra thick closure around radio
- VELCRO® loop to stabilize top of radio

*Part No.*  
**1711-3060-(L)**



3M™ and Scotchlite™ are trademarks of 3M™ used under license by IFR Workwear Inc. in Canada.

THE TRUSTED LEADER IN **QUALITY FLAME AND ARC RESISTANT WORKWEAR**

[www.ifrworkwear.ca](http://www.ifrworkwear.ca) | 403-347-5480 | [info@ifrworkwear.ca](mailto:info@ifrworkwear.ca)



# DISTRIBUTOR SUPPORT PRODUCTS

## IFR Branded Image Library

- Full colour branded product photos
- Full logo pack
- Slick Riggins and Ruby mascot art
- Available through Dropbox for easy download



## IFR Product Sell Sheets

- Full colour IFR Workwear sell sheets
- Available in high resolution PDF
- Always up to date
- Available through Dropbox, website and eCommerce store for easy download

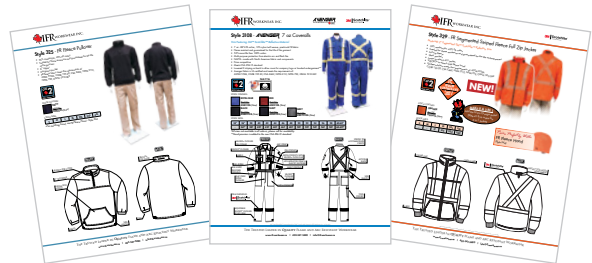

## IFR Posters

- Full colour IFR Workwear posters
- Available in high resolution PDF
- Great for trade shows, sales and special events
- Available through Dropbox for easy download



## IFR Product Catalogue

- Full colour product photos
- Coil bound, heavy pages resist tearing
- Technical information and sizing charts
- Also available for download in 3 languages



Email [marketing@ifrworkwear.ca](mailto:marketing@ifrworkwear.ca) if you are looking for support for other marketing initiatives

To download a printable version of the 2020 IFR Workwear Inc. product catalogue, please go to:

[www.ifrworkwear.ca](http://www.ifrworkwear.ca)



# Additionally,

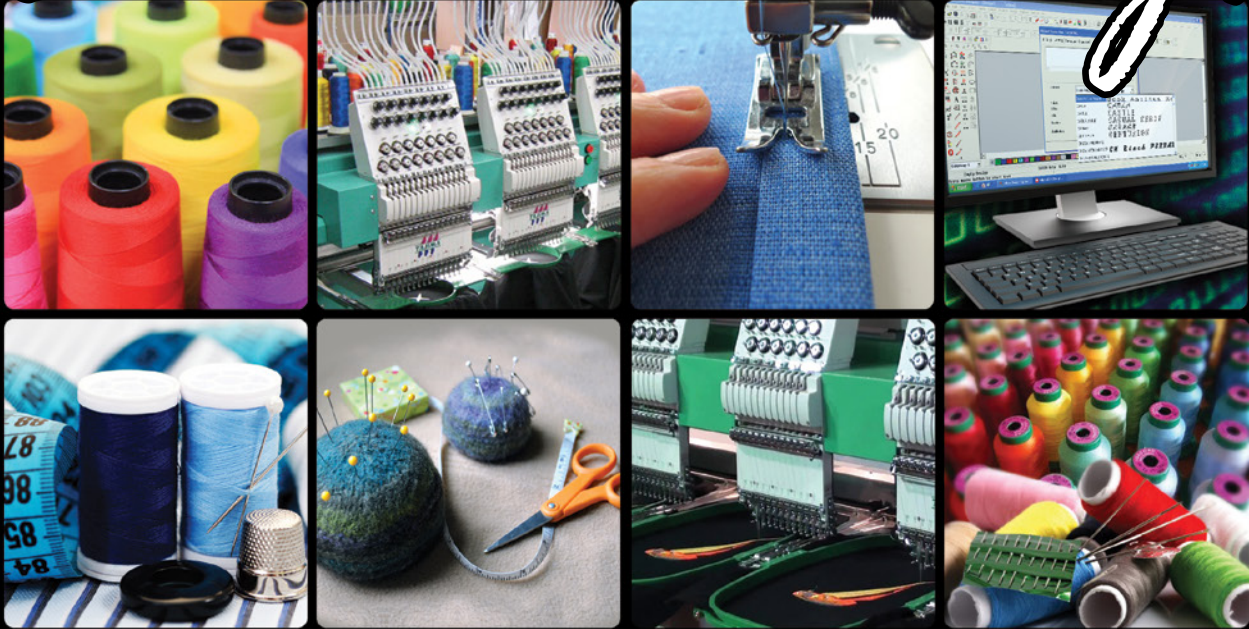

**IFR Workwear does more than just manufacture. Ask us about:**

- ✓ **Cresting**
- ✓ **Embroidery**
- ✓ **Alterations**
- ✓ **Digitizing**
- ✓ **Hemming**
- ✓ **Customizing**

IFR's state of the art 31,000 square foot distribution centre, located in northwest Red Deer is fully equipped with an in-house embroidery and sewing department. This means IFR Workwear can embroider company logos, install name tags, digitize logos, and do repairs, hemming or adjustments in our Red Deer facility.

*Plus,* the sizable warehouse enables IFR to keep goods in stock and shipping out quickly and efficiently!

## **Custom Orders:**

Please contact one of our IFR sales team members to discuss your custom order needs.



THE TRUSTED LEADER IN QUALITY FLAME AND ARC RESISTANT WORKWEAR

## Sizing Guidelines

- 1. Height** Stand straight against a wall without your shoes. Measure from the top of your head to the bottom of your feet.
- 2. Neck** Measure around the base of your neck where a collared shirt would fit, or measure a collarband on a shirt that fits you well. Lay the collarband flat. Measure from the beginning of the button hole to the centre of the button.
- 3. Chest** Measure well under your arms, across your shoulder blades and over the fullest part of your chest. Hold the tape firmly, but not tightly. Be sure the tape is level and straight across your back. Stand naturally.
- 4. Sleeve** Bend elbow slightly. Start at the centre, back of the neck and measure across the shoulder to the elbow and down to the wrist.
- 5. Waist** First, remove your belt. Then, measure over shirt (not over pants) at the position you normally wear your pants. Hold the tape firmly, but not tightly.
- 6. Hips** Stand with your heels together. Measure around the fullest part of your hips, holding the tape measure level.
- 7. Inseam** Use similar style pants that fit you well. Lay them flat, with the front and back creases smooth. Measure along the inside seam of one leg from the bottom of the hem to the crotch.

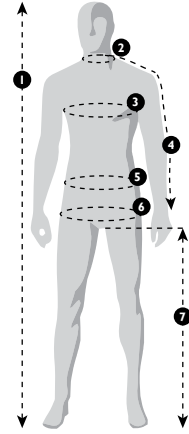

### ALPHA-NUMERIC

XS	32-34
S	36-38
M	40-42
L	44-46
XL	48-50
2XL	52-54
3XL	56-58
4XL	60-62
5XL	64-66

### COVERALL SIZING

Size/Tag	34	36	38	40	42	44	46	48	50	52	54	56	58	60	62	64	66	68	70
Chest	30	32	34	36	38	40	42	44	46	48	50	52	54	56	58	60	62	64	66
Waist	22	24	26	28	30	32	34	36	38	40	42	44	46	48	50	52	54	56	58
Neck	12.5	13	13.5	14	14.5	15	15.5	16	16.5	17	17.5	18	18.5	19	19.5	20	20.5	21	21.5
Weight (lbs)	140	150	160	170	180	190	200	210	220	230	240	250	260	270	280	290	300	310	320

### OUTERWEAR SIZING - PARKAS/COVERALLS

Size/Tag	XS	S	M	L	XL	2XL	3XL	4XL	5XL
Chest	32-34	36-38	40-42	44-46	48-50	52-54	56-58	60-62	64-66
Waist	26-28	30-32	34-36	38-40	42-44	46-48	50-52	54-56	58-60
Neck	13.5-14	14.5-15	15.5-16	16.5-17	17.5-18	18.5-19	19.5-20	20.5-21	21.5-22
Weight (lbs)	120-140	145-160	165-180	185-200	205-220	225-240	245-260	265-280	285-300

### WELDARMOR™ SIZING

Size/Tag	S	M	L	XL	2XL	3XL
Chest	19.25	21.25	23.25	25.25	27.25	29.25
Waist	19.25	21.25	23.25	25.25	27.25	29.25
Front Length	25	25.5	25.625	26.75	27.625	29.5

### OUTERWEAR SIZING - BIB PANTS

Size/Tag	S	M	L	XL	2XL	3XL	4XL
Chest	36-38	40-42	44-46	48-50	52-54	56-58	60-62
Waist	30-32	34-36	38-40	42-44	46-48	50-52	54-56
Weight (lbs)	145-160	165-180	185-200	205-220	225-240	245-260	265-280

### FLEECE PULLOVER SIZING

Size/Tag	S	M	L	XL	2XL	3XL	4XL
Chest	21	22.5	24	26	28	30	32
Neck	8.25	8.5	8.75	9.125	9.5	9.875	10.25

### FLEECE FULL-ZIP SIZING

Size/Tag	S	M	L	XL	2XL	3XL	4XL
Chest	21	22.5	24	26	28	30	32
Neck	8.25	8.5	8.75	9.125	9.5	9.875	10.25

### WORK SHIRT SIZING

Size/Tag	S	M	L	XL	2XL	3XL	4XL
Chest	30-32	34-36	38-40	42-44	46-48	50-52	54-56
Neck	18-19	19-20	20-21	21-22	22-23	23-24	24-25
Length Back	30.125	30.75	31.625	32.375	33.125	33.875	34.5

### WOMEN'S FLEECE SIZING

Size/Tag	XS	S	M	L	XL	2XL	3XL
Chest	18	19.5	21	22.5	24	25.5	27.5
Waist	16.5	18	19.5	21	22.5	24	26
Neck	6.25	6.5	6.75	7	7.25	7.5	7.875

### HENLEY SHIRT SIZING

Size/Tag	S	M	L	XL	2XL	3XL	4XL
Chest	30-32	34-36	38-40	42-44	46-48	50-52	54-56
Neck	18-19	19-20	20-21	21-22	22-23	23-24	24-25
Length Back	30	30.5	31	31.5	32	33.5	34.5

### WOMEN'S SHIRT SIZING

Size/Tag	XS	S	M	L	XL	2XL	3XL
Chest	18.5	20	21.5	23	24.5	26	28
Waist	17.5	19	20.5	22	23.5	25	27
Neck	6	6.25	6.5	6.75	7	7.25	7.875

### WORK PANT SIZING

Size/Tag	28	30	32	34	36	38	40	42	44	46	48	50
Waist	28	30	32	34	36	38	40	42	44	46	48	50

### 2 PIECE COVERALL WOMEN'S & MEN'S SIZING

Size/Tag	34	36	38	40	42	44	46	48	50	52	54
Chest	30	32	34	36	38	40	42	44	46	48	50
Waist	24	26	28	30	32	34	36	38	40	42	44
Neck	13	13.5	14	14.5	15	15.5	16	16.5	17	17.5	18
Weight (lbs)	140	150	160	170	180	190	200	210	220	230	240

### WOMEN'S PANT SIZING

Size/Tag	26	28	30	32	34	36	38	40
Waist	26	28	30	32	34	36	38	40

\*2 piece coverall tops were designed to fit women or shorter men.  
Most men will fit a tall jacket size.

\*\*2 piece coverall bottoms are measured with standard coverall sizing, not waist sizing.



## CSA Z96-15 Standard, Section 4.2.2 (hood provision)

### 4.2.2 Coloured stripes/bands — Configurations

The stripes/bands are oriented in such a way as to ensure that some part of them is visible from all angles around the body (i.e., 360° visibility).

Stripes/bands shall be laid out in the following distinctive standardized pattern for all classes:

- a) A waist-level horizontal stripe/band fully encircling the High Visibility Safety Apparel (HVSA);
- b) Two vertical stripes/bands on the front extending over the shoulders and down to the waist;
- c) A symmetric “X” on the back extending from the shoulders to the waist-level stripe/band; and
- d) For Class 3 apparel, in addition to this standard pattern, stripes/bands encircling both arms and both legs shall be added.



**Note: Hoods in their lowered position and other fold-back elements in the High Visibility Safety Apparel should not obscure the required stripes/bands.**

# X MEANS STOP

When you wear a CSA Z96 approved garment from IFR Workwear, it's easy to tell which direction you are facing:

**VERTICAL STRIPES MARK THE FRONT  
'X' MARKS THE BACK**

The 'drop-X' stripe style on the back maintains a visible symmetric 'X' even if a hood is worn.



## Standards Boards Reference Guide



### **CGSB (Canadian General Standards Board)**

The Canadian General Standards Board (CGSB) is a federal government organization that offers client-centered, comprehensive standards development and conformity assessment services in support of the economic, regulatory, procurement, health, safety and environmental interests of our stakeholders government, industry and consumers.



### **CSA (Canadian Standards Association)**

The Canadian Standards Association is a not-for-profit membership-based association serving business, industry, government and consumers in Canada and the global marketplace.

As a solution-oriented organization, the CSA works in Canada and around the world to develop standards that address the real needs, such as enhancing public safety and health, advancing the quality of life, helping to preserve the environment and facilitating trade.

The CSA helps people understand standards through education and information products and services. Each year, thousands of people benefit from the training materials, workshops and seminars offered by the CSA Learning Centre.



### **NFPA (National Fire Protection Association)**

The mission of the international non-profit NFPA is to reduce the worldwide burden of fire and other hazards on the quality of life by providing and advocating consensus codes and standards, research, training, and education. NFPA membership totals more than 81,000 individuals from around the world and more than 80 national trade and professional organizations.

Established in 1896, NFPA serves as the world's leading advocate of fire prevention and is an authoritative source on public safety. In fact, NFPA's 300 codes and standards influence every building, process, service, design, and installation in the United States, as well as many of those used in other countries. NFPA's focus on true consensus has helped the association's code-development process earn accreditation from the American National Standards Institute (ANSI).

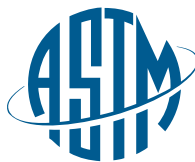

### **ASTM (American Society for Testing and Materials) International**

ASTM International is one of the largest voluntary standards development organizations in the world—a trusted source for technical standards for materials, products, systems, and services. Known for their high technical quality and market relevancy, ASTM International standards have an important role in the information infrastructure that guides design, manufacturing and trade in the global economy.



### **OSHA (Occupational Safety and Health Administration)**

OSHA's mission is to assure the safety and health of America's workers by setting and enforcing standards; providing training, outreach, and education; establishing partnerships; and encouraging continual improvement in workplace safety and health.



# Slick's Tips:

**What garment CAT rating do you require to keep your employees safe in the workplace?**

**Flame resistant clothing will minimize burn injury and provide the worker a few seconds escape time.**



**Canadian Electrical Standards (CSA-Z462)**



**National Fire Protection Association (NFPA 70E)**

CAT stands for Hazard Risk Category (measured in ATPV). It indicates the respective hazard/risk category (HRC) associated with each task.

**Arc Thermal Protection Value (ATPV) is how much heat the fabric withstands in testing.**

**CAT 1 = ATPV between 4-7 cal/cm<sup>2</sup>**  
**CAT 2 = ATPV between 8-24 cal/cm<sup>2</sup>**  
**CAT 3 = ATPV between 25-39 cal/cm<sup>2</sup>**  
**CAT 4 = ATPV 40 cal/cm<sup>2</sup> or more**



**Canadian Flash Fire Standard (CGSB 155.20)**



**National Fire Protection Association (NFPA 2112)**

- Workwear for protection against unplanned exposure to flash fire.
- Flame resistant workwear provides a level of protection and reduces the severity of burn injury.
- Flame resistant workwear should be worn as the outermost garment.





# IFR WORKWEAR INC.

*Celebrating 15 Years of Excellence*

---

THE TRUSTED LEADER IN QUALITY FLAME & ARC RESISTANT WORKWEAR

---

99 Quinn Avenue, Red Deer, Alberta T4P 0R7 Canada

PHONE: 403-347-5480 | FAX: 403-347-0070 | TOLL FREE: 1-888-550-6006 | EMAIL: [info@ifrworkwear.ca](mailto:info@ifrworkwear.ca)

[www.ifrworkwear.ca](http://www.ifrworkwear.ca)

3M | **Scotchlite**  
Reflective Material

**AVENGER**  
WORKWEAR BY IFR

**WESTEX**  
MILKMAN

DuPont™  
**NOMEX** IIIA

**WELDARMOR**  
BY IFR

IFR RAINWEAR

 **IFR BaseWear**