

**Master
Lock®**

**AMERICAN
LOCK®**



END-TO-END SAFETY SOLUTIONS

LOCKOUT PADLOCKS | LOCKOUT DEVICES | LOCKOUT SERVICES

Custom-Built Padlocks & Safety Lockout Products

READY TO SHIP IN 48 HOURS!



When customers need products in a hurry, the Express Program delivers. Products are ready to ship in 48 hours!

The most popular custom-built Master Lock safety padlocks and American Lock safety and security padlocks are available to order.

For OSHA safety lockout situations, the Express Program also offers a full line of safety lockout devices and accessories.

- Order Online: masterlockshop.com
- Order by Email: lockexpressorders@mlock.com
- Order by Dedicated Fax: 1-866-808-2705

Orders must be placed by 2 p.m. CST and clearly marked "Express" in order for shipment within 48 hours.



Anodized Aluminum Padlocks



Zenex™ Thermoplastic Padlocks



Steel Padlocks

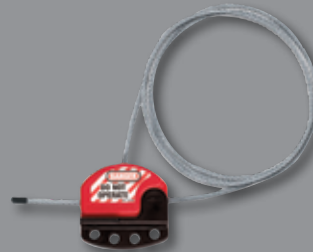

Cable Lockouts

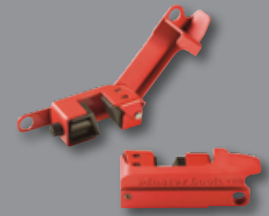

Electrical Lockouts



Valve Lockouts



Group Lock Boxes



Laminated Steel Padlocks



Hasps



Lockout Stations and Kits

Table of Contents

Padlocks, Identification, & Accessories



Zenex™ Thermoplastic Safety Padlocks **P6-8**



Safety Padlock Keyed-Alike Sets **P9**



Aluminum Safety Padlocks **P10-11**



Steel Safety Padlocks **P12**



Padlock Identification **P13**



Padlock Accessories **P14**

Lockout Devices



Hasps **P15**



Electrical Lockouts **P16-18**



Valve Lockouts **P19-20**



Cable Lockouts **P21**



Group Lock Boxes **P22-23**



Permit Control Station **P24**



Blind Flange & Pneumatic Lockouts **P25**

Lockout Devices (continued)



Electrical Covers **P26-27**

Lockout Kits & Stations



Lockout Kits **P28-29**



Padlock Stations **P30**



Compact Stations **P31**



Lockout Stations **P32-33**

Signs & Tags



Safety Tags **P34-35**



Guardian Extreme™ Safety Tags **P36**

Planograms



Safety Lockout Planograms **P37**

Professional Services & Software



Professional Lockout Services **P38**



Lockout Procedure Writing Software **P39**

Lockout/Tagout & OSHA Compliance

What is Lockout/Tagout?

In 1989, OSHA introduced Standard 29 CFR 1910.147 *The Control of Hazardous Energy* in order to establish lockout tagout compliance requirements for general industry. Lockout/Tagout is the process of controlling hazardous energy during the service and maintenance of machinery and equipment. These safety specific work procedures safeguard employees from accidental injuries or even death.

Why Lockout/Tagout?

The Control of Hazardous Energy (lockout/tagout) has been listed within OSHA's top 10 most frequently cited standards for several years. Non-compliance with this standard has resulted in thousands of worker related injuries and even deaths. Lockout/Tagout procedures are utilized to protect employees from the dangers of hazardous energy and ensure they go home safely every day.

For more information on Lockout/Tagout visit www.osha.gov

Master Lock offers the safety products and services you need to help you stay compliant

How to Implement a Lockout/Tagout System



The 1910.147 standard stated above establishes requirements for facilities to implement and employees to follow. In order to keep employees safe and to comply with the OSHA standard, facilities must:

- + **Develop** – create a lockout/tagout program specific to the machinery in your facility, including equipment that is not capable of being locked out
- + **Implement** – use lockout devices for equipment that can be locked out and tagout devices to identify who is performing maintenance
- + **Train** – teach employees the lockout/tagout procedures and be sure authorized employees can perform the procedure accurately
- + **Enforce** – monitor and maintain that the implemented procedures are being performed
- + **Inspect** – lockout/tagout procedures as well as employees should be audited at least annually

OSHA Requirements for Padlocks and Devices

The OSHA Lockout/Tagout standard outlines 5 requirements that all safety padlocks and devices must meet. Master Lock safety padlocks and devices were designed to meet all of these requirements.

Requirement	Description	Master Lock LOTO Products
Durable	Manufactured with materials that withstand usage environment	✓
Substantial	Cannot be removed unless considerable force is applied	✓
Standardized	Clearly differentiated from other devices by color, shape or size	✓
Identifiable	Indicates the authorized employee that applied the device	✓
Exclusive for Safety	Not to be used for purposes other than controlling energy	✓

Keying: A Critical Component

“One Employee, One Lock, One Key”

It is important that each employee at a facility has a padlock key that is unique to them. Key charting is critical to prevent duplicate keys from entering the workplace and jeopardizing your lockout/tagout program.



Master Lock offers keying services and options to meet any safety system's requirements

LifeGuard™

A no-charge Safety Lockout Padlock Key Charting System – critical for Safety Lockout

- Key charting is a record of all the safety padlock key codes assigned to a facility
- It is important that each authorized employee at a site has a unique padlock key that only opens that employee's safety padlock. This complies with the “one lock, one employee, one key” directive
- To help prevent duplicate keys from jeopardizing your lockout program, register your workplace with Master Lock. Once registered, Master Lock will send you an End User Identification Number for your site's Key Chart
- When you use that I.D. number on each additional padlock order, Master Lock will use a new key code for each padlock we manufacture for you. When used properly, this free service helps ensure that each employee carries a key unique to them, eliminating unwanted key duplication in a safety lockout program
- Locate the Master Lock End User Registration form and instructions at www.masterlock.com

Keying Options to fit your facility's needs

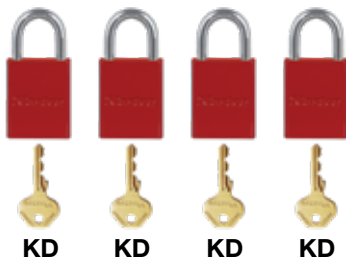

Keyed Different
Each lock is opened by its own unique key which does not open any other lock in the set – complying with the “One lock, one employee, one key” mantra

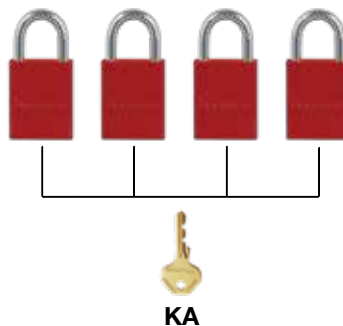

Keyed Alike
All padlocks in the set are opened by the same key so only one key is necessary to open numerous padlocks – for employees who need many locks, they still only have one key

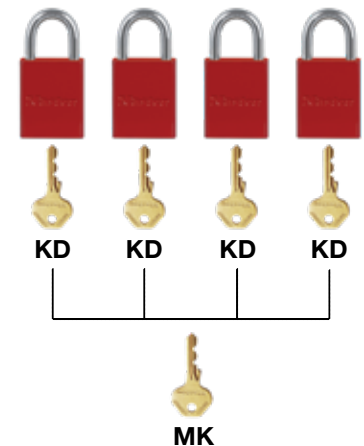

Master Keyed
A master key opens all locks within the system while each lock also has its own unique key – allows for responsible removal of improperly placed or forgotten lockouts according to your emergency notification policy

ZENEX™ THERMOPLASTIC SAFETY PADLOCK FEATURES

Zenex™ Thermoplastic Safety Padlocks

Optimal safety padlock designed exclusively for Lockout/Tagout by Safety Directors. Distinctive Zenex™ Thermoplastic safety padlock is durable, standardized, substantial and identifiable for OSHA 1910.147 compliance. Stands up to chemicals, temperature extremes, and is UV stable.



410

- ▶ Durable padlocks weigh only ounces (400 series 4 oz., S30 Series 3 oz.), making it easy to carry many
- ▶ Withstands extreme temperatures
- ▶ Excellent corrosion resistance
- ▶ UV stable
- ▶ No silicone used in padlock
- ▶ Over 40,000 unique safety key codes available.
- ▶ Keyed Different, Keyed Alike and Master Keyed options
- ▶ Key retaining – ensures padlock is not accidentally left unlocked. S33 non key-retaining for group lockout
- ▶ Available in up to 8 colors
- ▶ Includes one key to ensure compliance with “One Lock, One Employee, One Key” directive
- ▶ Includes write-on “Danger” and “Property Of” labels
- ▶ Body sides and face can be laser engraved for permanent identification
- ▶ Non-rekeyable ensures your safety lockout system stays pure by preventing haphazard rekeying and the accidental introduction of duplicate key codes
- ▶ Your facility’s padlocks can be key charted to ensure no duplicate key numbers are supplied and accidentally handed out to multiple employees
- ▶ Virtually all components are made in the U.S.A.

4100RJ
with
S142
Label

410RED

**Designed
by Safety
Directors**

**Dielectric
Protection**

410LTGRN

406RED

406BLU

406BLK with
S142 Label

**Multilingual
Labels
Available**

411LTTEAL

411YLW with
0411-5705
Label

411PRP

RED YLW GRN BLU BLK TEAL PRP ORJ

410 Zenex™ Thermoplastic Safety Padlock

- ▶ 1/4in diameter, 1-1/2in or 3in high plated metal shackles
- ▶ High security, reserved for safety cylinder
- ▶ Key-retaining, ensures padlock is not accidentally left unlocked
- ▶ English, Spanish, and French labels included

Master Lock Model #	Description	Vertical Shackle Clearance (B)	Schematic
410 Safety Padlocks			
1-1/2in Wide, 1-3/4in High Zenex™ Thermoplastic Body. Shackle Dimensions: A: 1/4in C: 25/32in			
410RED	Keyed Different	1-1/2in	
410LTRED	Keyed Different, Extra Length Shackle	3in	
410REDCOV	Keyed Different with Extreme Environment Safety Padlock Cover	1-1/2in	
410KARED	Keyed Alike	1-1/2in	
410KALTRED	Keyed Alike, Extra Length Shackle	3in	
410MKRED	Master Keyed	1-1/2in	
410KAMKRED	Keyed Alike, Master Keyed		
Eight Color Options: Add Desired Color Suffix: RED, YLW, GRN, BLU, BLK, TEAL, PRP, ORJ			
S140	Write on North American English, Spanish, and French. Multilingual label options available. (50 labels/language)		
S142	North American English, Spanish & French Padlock Labels for 406, 410, S31 & S33 (6 pk.)		



410RED

Keyed Alike Sets Available

406 Zenex™ Thermoplastic Non-Conductive, Non-Magnetic, Non-Sparking Safety Padlock

- ▶ Ideal for medical, mining & electrical lockout
- ▶ 1/4in diameter, 1-1/2in high nylon shackle with Zenex™ Thermoplastic body
- ▶ All components are non-sparking and non-magnetic plastic, copper, or brass
- ▶ Exposed components are plastic and do not conduct electricity
- ▶ Shackle withstands over 300 lb pull force

Master Lock Model #	Description	Vertical Shackle Clearance (B)	Schematic
406 Non-Conductive, Non-Magnetic, Non-Sparking Safety Padlocks			
1-1/2in Wide, 1-3/4in High Zenex™ Thermoplastic Body. Shackle Dimensions: A: 1/4in C: 25/32in			
406RED	Keyed Different, Dielectric	1-1/2in	
406REDCOV	Keyed Different with Extreme Environment Safety Padlock Cover		
406KARED	Keyed Alike		
406MKRED	Master Keyed		
406KAMKRED	Keyed Alike, Master Keyed		
Eight Color Options: Add Desired Color Suffix: RED, YLW, GRN, BLU, BLK, TEAL, PRP, ORJ			
S140	Write on North American English, Spanish, and French. Multilingual label options available. (50 labels/language)		
S142	North American English, Spanish & French Padlock Labels for 406, 410, S31 & S33 (6 pk.)		



406YLW

Keyed Alike Sets Available

411 Zenex™ Thermoplastic Bilingual Safety Padlock

- ▶ 3in tall body with 1/4in diameter, 1-1/2in or 3in high plated metal shackles
- ▶ High security, reserved for safety cylinder
- ▶ English/Spanish and English/French combined labels

Master Lock Model #	Description	Vertical Shackle Clearance (B)	Schematic
411 Bilingual Safety Padlocks			
1-1/2in Wide, 3in High Zenex™ Thermoplastic Body. Shackle Dimensions: A: 1/4in C: 25/32in			
411RED	Keyed Different	1-1/2in	
411REDCOV	Keyed Different with Extreme Environment Safety Padlock Cover		
411LTRED	Keyed Different, Extra Length Shackle	3in	
411KARED	Keyed Alike	1-1/2in	
411KALTRED	Keyed Alike, Extra Length Shackle	3in	
411MKRED	Master Keyed	1-1/2in	
411KAMKRED	Keyed Alike, Master Keyed		
Eight Color Options: Add Desired Color Suffix: RED, YLW, GRN, BLU, BLK, TEAL, PRP, ORJ			
S141	Write on North American English/Spanish, English/French. Bilingual options available. (50 labels/language)		
0411-5705	Photo ID labels for 411 padlocks (6 pk.)		



411BLU

Keyed Alike Sets Available



S31 Global Zenex™ Thermoplastic Safety Padlock

- ▶ 3/16in marine grade 316 stainless steel shackle for superior corrosion resistance
- ▶ Key retaining – ensures padlock is not accidentally left unlocked
- ▶ Available with 1-1/2in or 3in tall shackle
- ▶ Patented

S32 Zenex™ Thermoplastic Dielectric Safety Padlock

- ▶ Non-Conductive, Non-Magnetic, Non-Sparking Safety Padlock – all components are plastic, copper or brass
- ▶ Ideal for medical, military, mining & electrical lockout
- ▶ 3/16in diameter x 1-1/2in high plastic shackle
- ▶ Non key retaining – padlock can be left unlocked and snap locked as needed. Ideal for use during group lockout
- ▶ Patented

S33 Global Zenex™ Thermoplastic Snap Lock Safety Padlock

- ▶ 3/16in marine grade 316 stainless steel shackle for superior corrosion resistance
- ▶ Non key retaining – padlock can be left unlocked and snap locked as needed. Ideal for use during group lockout
- ▶ Available with 1-1/2in or 3in tall shackle
- ▶ Patented

Master Lock Model #	Description	Vertical Shackle Clearance (B)	Schematic	
Zenex™ Thermoplastic Safety Padlock				
1-3/8in Wide, 1-7/8in High Zenex™ Thermoplastic Body. Shackle Dimensions: A: 3/16in C: 5/8in				
S31RED	Keyed Different	1-1/2in		
S31LTRED	Keyed Different, Extra Length Shackle	3in		
S31KARED	Keyed Alike	1-1/2in		
S31KALTRED	Keyed Alike, Extra Length Shackle	3in		
S31MKRED	Master Keyed	1-1/2in		
S31KAMKRED	Keyed Alike, Master Keyed			
Zenex™ Thermoplastic Dielectric Safety Padlock				
1-3/8in Wide, 1-7/8in High Body. Shackle Dimensions: A: 3/16in C: 5/8in				
S32RED	Keyed Different	1-1/2in		
S32KARED	Keyed Alike			
S32MKRED	Master Keyed			
S32KAMKRED	Keyed Alike, Master Keyed			
Zenex™ Thermoplastic Snap-Lock Safety Padlock				
1-3/8in Wide, 1-7/8in High Zenex™ Thermoplastic Body. Shackle Dimensions: A: 3/16in C: 5/8in				
S33RED	Keyed Different	1-1/2in		
S33REDCOV	Keyed Different with Extreme Environment Safety Padlock Cover			
S33LTRED	Keyed Different, Extra Length Shackle	3in		
S33KARED	Keyed Alike	1-1/2in		
S33KALTRED	Keyed Alike, Extra Length Shackle	3in		
S33MKRED	Master Keyed	1-1/2in		
S33KAMKRED	Keyed Alike, Master Keyed			
Nine Color Options: Add Desired Color Suffix: RED, YLW, GRN, BLU, BLK, TEAL, PRP, ORJ				
S30COVERS	Extreme Environment Safety Padlock Covers; bag of 12 covers – see page 15			
S140	Write on North American English, Spanish, and French. Multilingual label options available. (50 labels/language)			
S142	North American English, Spanish & French Padlock Labels for 406, 410, S31 & S33 (6 pk.)			



Keyed Alike Sets Available



410KAS3

Safety Padlock Keyed-Alike Sets

Popular quantities of safety padlocks are conveniently packed in sets, simplifying the order process.

Safety Padlock Keyed-Alike Sets

Safety Padlocks Built and Packed in Popular Keyed Alike Quantities

Workers often need to lock out more than one energy source on a single piece of equipment. Keyed alike safety padlocks can help serve this purpose.

To simplify and expedite ordering, Master Lock now offers our Zenex™ Thermoplastic, Aluminum and Steel safety padlocks in popular keyed alike quantities – sets of 3, 6, or 12 locks. These locks are ordered as “1” unit and are packed together making them easy to distribute.

“n” Denotes quantity of padlocks per keyed alike set. Choose quantity and color of set(s) at time of purchase.	
Master Lock Model	Description
Zenex™ Thermoplastic Safety Padlocks, 1/4in dia shackle	
406KASn	Choose quantity per set; 3, 6, or 12 (e.g. 406KAS12RED = twelve red 406KA Padlocks)
410KASn	
411KASn	
Six Color Options: Add Desired Color Suffix: RED, ORJ, YLW, GRN, BLU, BLK	
Zenex™ Thermoplastic Safety Padlocks, 3/16in dia shackle	
S31KASn	Choose quantity per set; 3, 6, or 12 (e.g. S31KAS3BLU = three blue S31KA Padlocks)
S33KASn	
Six Color Options: Add Desired Color Suffix: RED, ORJ, YLW, GRN, BLU, BLK	
Anodized Aluminum Safety Padlocks, 1/4in dia shackle	
A1105KASn	Choose quantity per set; 3, 6, or 12 (e.g. A1105KAS6GRN = six green A1105KA Padlocks)
A1106KASn	
Four Color Options: Add Desired Color Suffix: RED, BLU, GRN, YLW	
Laminated Steel, 9/32in dia shackle	
3KASn	Choose quantity per set; 3, 6, or 12 (e.g. 3KAS12YLW = twelve yellow 3KA Padlocks)
Six Color Options: Add Desired Color Suffix: RED, YLW, GRN, BLU, BLK, WHT.	

Note: Contact Master Lock Customer Care to supply your site’s End User Registration ID Number and the key numbers received to update your site’s Key Chart.



410KAS3RED



411KAS6YLW



A1106KAS12BLU



S1105RED

Aluminum Safety Padlocks

Lightweight and durable aluminum body with anodized finish for Lockout/Tagout. Stands up to chemicals, temperature extremes, and is UV stable.

ALUMINUM SAFETY PADLOCK FEATURES

- ▶ Durable padlock weighs 5 ounces, making it easy to carry
- ▶ Solid body construction stands up to physical abuse
- ▶ UV stable
- ▶ 1/4in diameter boron steel shackle with plated finish for corrosion resistance
- ▶ Available Keyed Different, Keyed Alike and Master Keyed
- ▶ Available with 1in, 1-1/2in or 3in tall shackle
- ▶ Write on labels and Photo ID labels available
- ▶ Body sides and face can be laser engraved for permanent identification – 6 available spaces
- ▶ Uses FDA approved lubricants safe for use in food processing. No silicone used in padlock

S-series Aluminum Safety Padlocks

Designed specifically for Safety lockout

- ▶ Featuring the W401/W417 Safety Exclusive keyway
- ▶ Key retaining
- ▶ Over 40,000 key changes to meet your system needs
- ▶ Complies with the “One Lock, One Key per Employee” mantra
- ▶ Durable aluminum construction for supreme corrosion resistance
- ▶ LifeGuard™ key charting free of charge

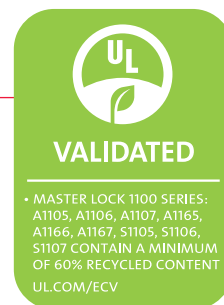

S1100 Series

Anodized aluminum no-chip finish – ideal for food processing facilities

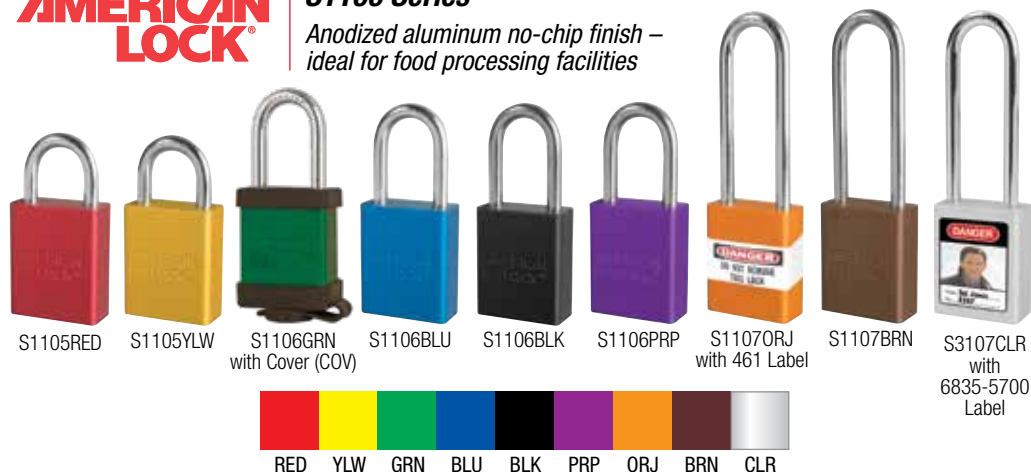

Model #	Description	Vertical Shackle Clearance (B)	Schematic
S1100 Series Anodized Aluminum Padlocks			
1.5in Wide, 1.820in High Anodized Aluminum Body. Shackle Dimensions: A: 1/4in C: 3/4in			
S1105RED	Keyed Different	1 in	
S1105REDCOV	Keyed Different with Extreme Environment Safety Padlock		
S1105KARED	Keyed Alike		
S1105MKRED	Master Keyed		
S1105KAMKRED	Keyed Alike, Master Keyed		
S1106RED	Keyed Different, Extra Length Shackle	1-1/2in	
S1106KARED	Keyed Alike		
S1106MKRED	Master Keyed		
S1106KAMKRED	Keyed Alike, Master Keyed		
S1107RED	Keyed Different, Extra Length Shackle	3in	
S1107KARED	Keyed Alike		
S1107MKRED	Master Keyed		
Also available as 6-pin; A1165, A1166, A1167			
Nine Color Options: Add Desired Color Suffix: RED, YLW, GRN, BLU, BLK, PRP, ORJ, BRN, CLR			
S101	Extreme Environment Safety Padlock Covers; bag of 12 covers – see page 15		
6835-5700	Photo ID labels for S1100/A1100 series padlocks – 1-1/4in W x 1-3/4in T		
461	Padlock labels with clear overlaminate (50 pk.) - 5in W x 1in T		

Standard Aluminum Padlocks

Anodized Aluminum Safety Padlocks

American Lock A1100 Series



- ▶ Available in 9 colors
- ▶ Durable anodized finish suitable for lockout in food processing facilities
- ▶ Over 10,000 key changes available

American Lock A3100 Series

- ▶ Interchangeable Core Cylinder. Small Format
- ▶ Over 101,000 key changes available



American Lock Model #	Description	Vertical Shackle Clearance (B)	Schematic
A1100 Series Anodized Aluminum Padlocks			
1.5in Wide x 1.820in High Anodized Aluminum Body. Shackle Dimensions: A: 1/4in C: 3/4in			
A1105RED	Keyed Different	1in	
A1105KARED	Keyed Alike		
A1105MKRED	Master Keyed		
A1105KAMKRED	Keyed Alike, Master Keyed	1-1/2in	
A1106RED	Keyed Different, Extra Length Shackle		
A1106KARED	Keyed Alike		
A1106MKRED	Master Keyed		
A1106KAMKRED	Keyed Alike, Master Keyed	3in	
A1107RED	Keyed Different, Extra Length Shackle		
A1107KARED	Keyed Alike		
A1107MKRED	Master Keyed		
Also available as 6-pin; A1165, A1166, A1167			
A3100 Series Interchangeable Core Anodized Aluminum Padlocks			
1.5in Wide x 1.820in High Anodized Aluminum Body. Shackle Dimensions: A: 1/4in C: 3/4in			
A3105RED	Keyed Different	1in	
A3106RED	Keyed Different, Extra Length Shackle	1-1/2in	
A3107RED	Keyed Different, Extra Length Shackle	3in	
Also available as 6-pin; A3165, A3166, A3167			
Nine Color Options: Add Desired Color Suffix: RED, YLW, GRN, BLU, BLK, PRP, ORJ, BRN, CLR			
COV	Extreme Environment Safety Padlock Cover option; add 'COV' to end of Product No. to order (e.g. S1105REDCOV)		
6835-5700	Photo ID labels for S1100/A1100 series padlocks – 1-1/4in W x 1-3/4in T		
461	Padlock labels with clear overlamine (50 pk.) - 5in W x 1in T		



Keyed Alike Sets Available – A1105 and A1106 padlocks

STEEL SAFETY PADLOCK FEATURES

- ▶ Weighs approximately 7 ounces
- ▶ Can withstand extreme temperatures
- ▶ 9/32in diameter shackle
- ▶ Available with 3/4in, 1-1/2in or 2in tall shackle
- ▶ 6 bumper colors available
- ▶ Keyed Different, Keyed Alike and Master Keyed options
- ▶ Over 1400 unique key codes available
- ▶ Optional stamping of key code in key and on bottom plate of padlock available
- ▶ Wrap around, write on labels available for identification
- ▶ Your facility's padlocks can be key charted to ensure no duplicate key numbers are supplied and accidentally handed out to multiple employees
- ▶ Virtually all components made in the U.S.A.
- ▶ Uses FDA approved lubricants safe for use in food processing

Steel Safety Padlocks

Strong and economical. Reinforced laminated steel construction stands up to extreme physical abuse.

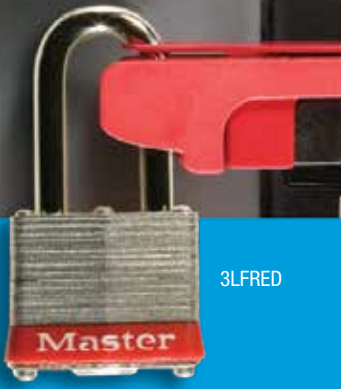

3LFRED



3RED

3YLW

3LHBLU

3LHWHT

3LFGRN

3LFBLK

3LFRED and 3RED with 461 Label

3 Steel Safety Padlock

Master Lock Model #	Description	Vertical Shackle Clearance (B)	Schematic
1-9/16in Wide Laminated Steel Body. Shackle Dimensions: A: 9/32in C: 5/8in			
3RED	Keyed Different	3/4in	
3LFRED	Keyed Different, Extra Length Shackle	1-1/2in	
3LHRED	Keyed Different, Extra Length Shackle	2in	
3KARED	Keyed Alike	3/4in	
3KALFRED	Keyed Alike, Extra Length Shackle	1-1/2in	
3KALHRED	Keyed Alike, Extra Length Shackle	2in	
3MKRED	Master Keyed	3/4in	
3KAMKRED	Keyed Alike, Master Keyed		
Six Color Options: Add Desired Color Suffix: RED, YLW, GRN, BLU, BLK, WHT.			
461	Padlock labels with clear overlamine (50 pk.)		

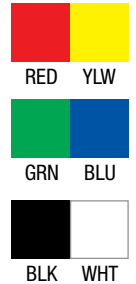

Keyed Alike Sets Available

Breakaway Shackle Padlock

Laminated Steel Padlock with Breakaway Shackle for Emergency Access

- ▶ Ideal for emergency situations where emergency access is needed, such as fire extinguishers and hoses

NOTE: Does not meet OSHA 1910.147 Lockout/Tagout Standard

Master Lock Model #	Description	Vertical Shackle Clearance (B)
500KABRK	Keyed Alike, Warded Locking Mechanism. Breakaway Shackle	13/16in



500KABRK



Laser Engraving

Laser Engraving

A Permanent and Durable Method to Customize Your Safety Lockout Padlocks

- ▶ Available on Aluminum and Zenex™ Thermoplastic padlocks
- ▶ A name, logo or key number, you select the important information to engrave on the padlock
- ▶ Laser engrave information on the padlock face, sides or back
- ▶ Contact your preferred distributor or Master Lock for ordering and pricing information
- ▶ Available in many languages; call for details
- ▶ Visit www.masterlocksafety.com to see sample engraving on all lock styles and colors



Padlock Identification

Master Lock has the most comprehensive offering of padlock identification options available.

Padlock Identification Labels



0411-5705



6835-5700



461



S142



Master Lock Model #	Description	Dimensions
0411-5705	Photo ID labels for 411 padlocks (6 pk.)	1in W x 2-3/8in T
6835-5700	Photo ID labels for A1105, A1106, A1107, A1165, A1166, and A1167 padlocks (6 pk.)	1-1/4in W x 1-3/4in T
461	Padlock labels with clear overlaminates (50 pk.)	5in W x 1in T
S140	North American English, Spanish & French Padlock Labels for 410, 406, S31 & S33 (50 labels/language)	1in W x 1-3/16in T
S141	North American English/Spanish, & English/French Padlock Labels for 411 padlocks (50 labels/language)	1in W x 2-3/8in T
S142	Photo ID labels for 410, 406, S31, and S33 Padlocks (6 pk.)	1in W x 1-1/4in T

Extreme Environment Safety Padlock Covers

- ▶ Seals shackle and keyway to help keep out dust and grime from extreme environments
- ▶ Dual strap increases durability and minimizes the obstruction of labels
- ▶ Removable attached keyway cap allows for easier access to keyway (not included on S30COVERS)
- ▶ Available for American Lock S1100 Series and Master Lock S30 Series safety padlock families



Master Lock Model #	Description
S101	For American Lock S1100 and A1100 series padlocks; bag of 12 covers
S30COVERS	For Master Lock S31, S32 & S33 series padlocks; bag of 72 covers

Padlock Chains, Collars & Tags

- ▶ Chains keep padlocks close to equipment requiring safety lockout
- ▶ Engravable brass tag provides for individual worker identification
- ▶ Tags attach to safety lockout padlocks with 71SC8 and 71SC9 collars

Master Lock Model #	Description
71CS	9in long lightweight zinc plated steel chain with chain holder attached; fits all master shackle collars (ordered separately) (12 pk.)
71CH	9in long heavy-duty zinc plated steel chain with chain holder attached; fits all master shackle collars
71SC8	Shackle collar. Fits 1/4in diameter shackles and smaller; for 410, 411, S1100/A1100 padlocks
71SC9	Shackle collar. Fits 9/32in diameter shackles; for 3 laminated steel padlocks
71TAG	1/2in x 1-3/4in brass tag with ring for attaching to shackle collars listed above



71TAG

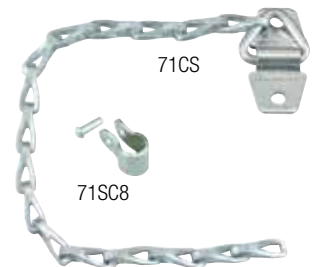

71CS

71SC8

Safety Padlock Caddy

- ▶ Keep safety padlocks near appropriate machinery
- ▶ Hold up to 12 padlocks based on number of lockout points
- ▶ When locking out, conveniently carry caddy to all lockout points
- ▶ When all padlocks are gone, all lockout points have been met

Master Lock Model #	Description
S125	Safety Padlock Caddy – Carry up to 12 padlocks from lockout job to job



S125 Safety Padlock Caddy

Padlock Accessories

Safety lockout accessories for OSHA compliance.

S101



Hasps

Lockout hasps are integral parts of a successful safety lockout program, providing effective multi-person lockout.

Safety Lockout Hasps

Lockout by Multiple Workers at Each Lockout Point

- ▶ Attach hasp to energy disconnect switch
- ▶ Control cannot be turned on until last worker's padlock is removed from hasp
- ▶ Multiple styles available to fit most needs; **Spark resistant aluminum, Pry-resistant steel, Dielectric plastic, Dual jaw aluminum**

Aluminum



416

417

Tabbed Steel



AL080

AL0802

Steel



420

421

4mm Dia. Shackle Hasp



S430

Heavy Duty Steel



418



419

Dual Jaw Aluminum



429

Dielectric



428

Master Lock Model #	Description	Inside Jaw Clearance	Padlock Capacity
416	Spark Resistant Aluminum 1-1/2in x 4-3/8in	1in	6
417	Spark Resistant Aluminum 2in x 4-7/8in	1-1/2in	6
418	Heavy Duty Steel 2-3/8in x 3-1/4in	1in	4
419	Heavy Duty Steel 2-3/8in x 6-5/8in	3in	8
420	Steel Jaw with Vinyl Coated Handle 1-3/4in x 4-1/2in	1in	6
421	Steel Jaw with Vinyl Coated Handle 2-3/8in x 5in	1-1/2in	6
428	Nylon Non-Conductive Hasp 1-5/8in x 6-7/8in	1in x 2-1/2in	6
429	Dual Jaw Aluminum Hasp 2in x 5-7/8in	1in & 1-1/2in	8
AL080	Tabbed Steel Jaw with Vinyl Coated Handle 1-3/4in x 4-1/2in	1in	6
AL0802	Tabbed Steel Jaw with Vinyl Coated Handle 2-3/8in x 5in	1-1/2in	6

Model 427 – Labeled Snap-On Hasp

- ▶ Combines multiple-person lockout and tagout identification
- ▶ Features an easy-to-apply “snap-on” advantage with its spring-loaded locking arm
- ▶ Fits more lockout points than alternative rivet-hinge labeled lockout hasps
- ▶ Anodized aluminum and stainless steel construction for combined corrosion-resistance and strength
- ▶ Complete with high visibility, re-usable, write-on safety labels (English, French & Spanish)



427



Master Lock Model #	Description	Inside Jaw Clearance	Padlock Capacity
427	Red Labeled Snap-On Hasp 2-7/8in x 7in	1-3/4in x 2-1/8in	5

Grip Tight™ Plus Circuit Breaker Lockouts

Reliable Lockout in More Circuit Breaker Applications

- ▶ Dependability - Consistently attach to breakers and remain secure
- ▶ Efficiency - Compatible with wide variety of circuit breaker handle shapes and sizes
- ▶ Ease of Use - Lightweight, one-piece designs that require no tools for installation
- ▶ Exclusive design features:
 - Model S3821 is compact, which allows for locking out adjacent breakers
 - Model S3821 is suitable for locking out multi-pole breakers and works with most tie-bar toggles
 - Model S3822 has a permanently fixed cleat, which adds physical blocking capability
 - Model S3823 has a fold-down cleat that provides enhanced switch throw blocking when needed

Master Lock Model #	Description
S3821	Lockout Device for Miniature Circuit Breakers (120/240 V)
S3822	Lockout Device for Molded Case Circuit Breakers (480/600 V)
S3823	Lockout Device for Oversized Handle Circuit Breakers (480/600 V)

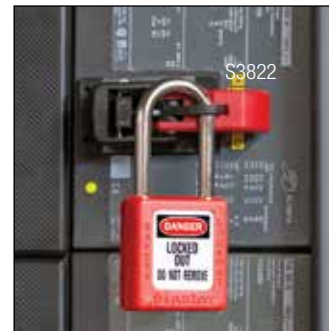

Electrical Lockouts

Master Lock offers innovative, patented and patent pending devices for the effective lockout of electrical shut-off points, including circuit breakers, and electrical plugs.

Fold-Down Cleat
Provides enhanced switch throw blocking when needed



Large Thumbscrew
Knurled texture enables gripping with gloves, offering easy tightening for a secure lockout. Slotted to allow optional screwdriver adjustment



Toothed Jaw
Delivers a tight hold on the circuit breaker handle



Curved Blade
Ensures two-point contact with the switch handle for greater hold

Fixed Cleat
Provides added physical blocking to prevent switch from turning to "on" position

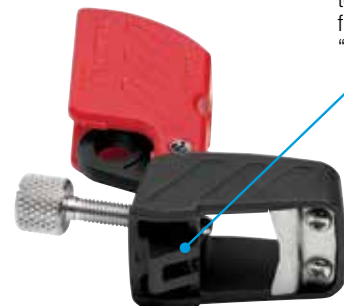

Grip Tight™ Circuit Breaker Lockout

Simplicity Combined with Durability for Effective Lockout

- ▶ Secure and simple mounting for a solid lockout. Holds tight with simple thumb turn and clamping handle
- ▶ Different profiles intended to accommodate unique breaker sizes
 - Model 491B fits tall and wide breaker toggles
 - Model 493B fits standard height and some common tie-bar toggles
- ▶ Compact devices are easy to carry and easy to store
- ▶ Both devices accept all American Lock and Master Lock safety padlock shackle and lockout hasp diameters
- ▶ Durable construction with powder coated steel and reinforced polymer allows operation in harsh environments
- ▶ Patented

Master Lock Model #	Description
491B	Circuit Breaker Lockout – tall and wide toggles
493B	Circuit Breaker Lockout – standard single and double toggles
506	Set of each device – one 491B and one 493B



Miniature Circuit Breaker Lockouts

Locks Out Most Miniature ISO/DIN Circuit Breakers Found Throughout the World

- ▶ S2390 fits standard width toggle openings. Pin out. Black Handle
- ▶ S2391 fits wide toggle openings. Pin out. Red Handle
- ▶ S2394 features thumb-turn dial screw for easy attachment – no tools needed!
- ▶ Works with all Master Lock and American Lock safety padlocks and most lockout hasps
- ▶ S2390, S2391, S2392 Patented devices
- ▶ S2394 Patent pending

Master Lock Model #	Description
S2390	Fits pin-out breakers 11mm or less
S2391	Fits pin-out breakers 11mm to 13mm
S2392	Fits breakers with pin-in toggles
S2393	Fits universal breaker toggles
S2394	Fits universal breaker toggles, tool-free



S2394
Side-by-Side
Application



S2394
Horizontal
Application



S2394



S2393



S2390

S2391

S2392

Circuit Breaker Switch Padlock

Provides the Flexibility to Effectively Lock Out Breaker Switches

- ▶ 3/16in diameter cable shackle allows padlock to properly lock all types of circuit breaker lockout devices
- ▶ Flexible cable allows the compact lock body to be positioned so that the control panel door closes properly
- ▶ Fits the tight space constraints within circuit breaker shut-off boxes
- ▶ Numerous key changes are available to minimize the possibility of unwanted key duplication

Allows Panel Door to Close

Master Lock Model #	Description
7C5RED	1-1/8in wide steel body; 4-pin cylinder; 5in flexible steel cable. Keyed Different



Rotating Electrical Plug Lockouts

Outward/Inward Rotation Allows for Easier Application & Storage

- ▶ Surrounds the electrical plug; protects against accidental reconnection
- ▶ Unique, patented rotating design allows for easier installation in confined space applications
- ▶ Complete with high-visibility permanent safety labels (English, French & Spanish). Labels can be written-on to identify the responsible person, then erased for the next job
- ▶ Tough, lightweight, dielectric Zenex™ Thermoplastic bodies withstand chemicals; perform effectively in extreme conditions

Master Lock Model #	For Electrical Plug Sizes Up To:
487	2-1/4in dia. x 3-1/4in with cord dia. up to 3/4in (110-120 and 220-240 volt plugs)
488	3in dia. x 6in with cord dia. up to 3/4in (Most 240 and 550 volt plugs)



Compact Plug Prong Lockout

Compact Design Locks Out Smaller Plugs Easily & Effectively

- ▶ Locks on the prongs of 110-120 volt plugs
- ▶ Fits two prong plugs with and without ground
- ▶ Use with your existing lockout padlocks or lockout hasps
- ▶ Includes labels in English, Spanish, and French
- ▶ Patented



Master Lock Model #	Description
S2005	Fits 110-120-volt plugs (with or without ground)



S3081

Butterfly Valve Lockout Devices

Locks out virtually all butterfly valves

- ▶ Easy-to-use, adjustable design fits virtually all butterfly valves
- ▶ Locks out valve in seconds by feeding S806 cable lockout device through desired eyelet and around valve neck
- ▶ Stainless steel rivet allows device to smoothly pivot open and closed to ensure proper fit
- ▶ Durable, lightweight Zenex™ Thermoplastic material is chemical resistant and performs effectively in extreme environments
- ▶ Directional application arrows allow for ease of installation and minimize user error

Master Lock Model #	Description
S3920	Butterfly Valve Lockout Device only
S3921	Butterfly Valve Lockout Device + S806CBL3 Adjustable cable lockout

Valve Lockouts

The exclusive, patented Master Lock gate and ball valve lockout devices work in difficult applications like tight spaces and insulated pipes.

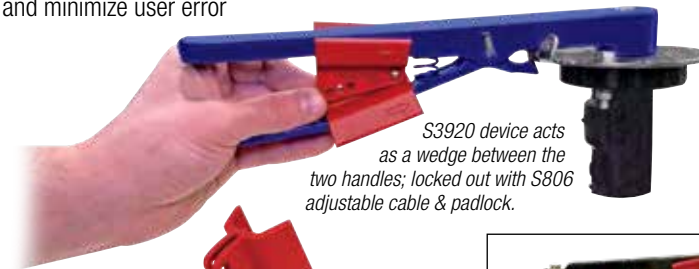

S3920 device acts as a wedge between the two handles; locked out with S806 adjustable cable & padlock.

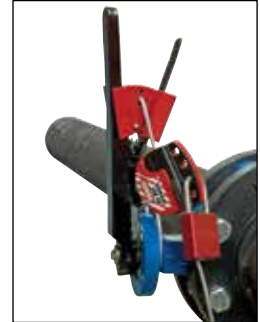

Rotating Gate Valve Lockouts

Outward/Inward Rotation Allows for Easier Installation & Storage

- ▶ Surrounds the valve operating handle to protect against accidental valve opening
- ▶ Multiple workers can apply their lockout hasps or personal safety locks
- ▶ Tough, lightweight, dielectric Zenex™ Thermoplastic bodies withstand chemicals; perform effectively in extreme conditions
- ▶ Unique, patented rotating design allows for easier installation in confined space applications
- ▶ Complete with high-visibility permanent safety labels (English, French & Spanish) that can be written-on to identify the responsible person, then erased for the next job
- ▶ Center knockout can be removed for rising stem gate valves
- ▶ Each size rotates into itself and nests within the next larger size to save space in storage

Master Lock Model #	Description	Depth	Stem Opening
480	1in to 3in dia. valve handles	1-1/16in	3/4in
481	2in to 5in dia. valve handles	1-1/2in	1-1/2in
482	4in to 6.5in dia. valve handles	1-7/8in	2-1/2in
483	6in to 10in dia. valve handles	2-3/4in	3-1/2in
484	8in to 13in dia. valve handles	3-3/8in	4in
485	1 set of 480-484		

Easy to Store Fits in Kits



485



480

482

483

481

Easy to Use Even in Tight Spaces

484



Pressurized Gas Valve Lockout

Fits Pressurized Gas Valves

- ▶ Patented design works with valve guard in place
- ▶ Fits virtually all pressurized gas valve handles up to 3in diameter
- ▶ Compact size easily stored when not being used
- ▶ Accepts any Master Lock or American Lock Safety Padlock
- ▶ Works with lockout hasps for multiple worker lockout



Master Lock Model #	Description	Depth	Stem Opening
S3910	Pressurized Gas Valve Lockout	1in	1-5/8in

Ball Valve Lockout Devices

Effective Lockout for Virtually Any Ball Valve

- ▶ Easy to use – simple, intuitive designs
- ▶ Broad application
 - Devices could lock up ball valves up to 4in
 - Fit virtually all types of pipe including insulated, PVC and metal
- ▶ Lightweight and compact – devices are easy to carry, store and apply even in tight, awkward spaces



S3068 Seal Tight™ Handle-On Lockout

Metal device clamps tight on handle stop. Defies corrosive environments and extreme temperatures.



S3068



468L



468L Seal Tight™ Handle-Off Lockout

Device encloses the valve stem, with the handle removed, to make accidental reactivation virtually impossible. Operates in extreme temperatures.



S3081



S3081 Adjustable Lockout

Works with S806 cable lockout device for the most secure fit.

S3476/S3477 1/4 Turn Ball Valve Lockout

Fits manual, quarter turn ball valve handles to protect against accidental opening. Easy to use one piece design locks valve in OFF position. Two rows of lock out points allow for a secure fit.

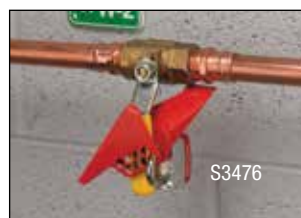

S3476



S3477

Master Lock Model #	Description	For Valve Diameters of:
S3068	Seal Tight™ Handle-On Ball Valve Lockout 5-3/4in L x 2-1/8in W x 2-1/2in H	1/4in to 4in
468L	Seal Tight™ Handle-Off Lockout, 11-1/2in H x 12-3/4in W x 2-1/2in D	3/8in to 4in
S3081	Adjustable Ball Valve Lockout	1/2in to 2in

Master Lock Model #	Description
S3476	Fits valves between 1/4in (6.35mm) to 1in (25mm) diameter
S3477	Fits valves between 1-1/4in (31mm) to 3in (76mm)

S856



Cable Lockouts

Innovative patented cable lockout devices offer efficient multipoint safety lockout compliance for a variety of safety applications.

Retractable Cable Lockouts

Adjustable cable lockout devices with Cable Management System for a variety of applications

- ▶ Cable take-up reel encloses the cable to provide protected storage and easy application by managing excess cable length during lockout
- ▶ Internal ratcheting mechanism ensures a secure lockout by only allowing the cable tension to increase, even after locks have been applied
- ▶ Patented 1/8in (3.3mm) diameter x 9ft (2.74m) cable features a colored plastic coating for added durability and visibility
- ▶ Tough, lightweight thermoplastic body withstands chemicals
- ▶ Ergonomic design eases operation when wearing gloves
- ▶ Contoured shape enables easy stacking, storage, and transportation of multiple devices
- ▶ Suitable for group or challenging, multi-point lockout
- ▶ Includes high-visibility, write-on safety labels in English, Spanish and French for easy identification (additional languages available)
- ▶ Replacement cable kits available separately with Steel or Nylon Core Cable; can use either cable type in same device

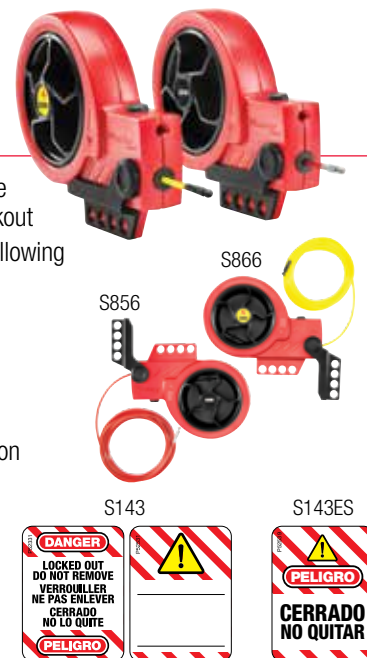

Master Lock Model #	Description
S856	Retractable cable lockout device with 9ft (2.74m) x 1/8in (3.3mm) dia. red steel core cable
S866	Retractable cable lockout device with 9ft (2.74m) x 1/8in (3.3mm) dia. yellow nylon core cable
Replacement Parts	
PKGP52709	Replacement cable kit - Steel core cable (Red)
PKGP52711	Replacement cable kit - Nylon core cable (Yellow)
Danger Labels for S856/S866	
S143	Trilingual danger labels (English, French, Spanish) and warning/write-on labels. Pack of 100 labels, 50 of each design
S143FR	Danger labels. French. Pack of 50 labels
S143ZH	Danger labels. Mandarin Chinese. Pack of 50 labels
S143ES	Danger labels. European Spanish. Pack of 50 labels
S143JA	Danger labels. Japanese. Pack of 50 labels
S143DE	Danger labels. German. Pack of 50 labels
S143NL	Danger labels. Flemish. Pack of 50 labels

Adjustable Cable Lockouts

Infinitely Adjustable for a Secure Fit Every Time

- ▶ Integrated safety hasp and cable are ideal for multi-point lockout
- ▶ Feed the cable end through the points to be locked out, then back through the lockout body. Cinch it tight to remove any slack with the patented locking feature
- ▶ Tough, flexible multi-stranded steel cable is insulated with a clear plastic coating
- ▶ Tough, lightweight Zenex™ Thermoplastic body withstands chemicals; performs effectively in extreme conditions (temperature range of -40° F to 200° F)
- ▶ Master Lock S806 includes a 6' cable. Cable available in 1ft increments from 7ft to 50ft
- ▶ Complete with high-visibility write-on safety labels (English, French & Spanish)



Master Lock Model #	Description
3/16in (4mm) Diameter Cable	
S806	6' Adjustable cable lockout
S806CBL3	3' Adjustable cable lockout
S806CBL15	15' Adjustable cable lockout
S806CBL n	Adjustable cable lockout with user-specified cable length of 7' to 50'



S600

Group Lock Box with Wall Mounting Bracket

Manage The Placement And Movement of Group Lock Boxes To Protect Your People

- ▶ Use it where it's needed – Mount with the bracket for routine, daily use; take it portable for remote lockouts; or move to a bracket in another area for large turnarounds
- ▶ Prevent unwanted box removal from the wall with optional locking of box to bracket
- ▶ Monitor the status of group lockouts at a glance with product features that improve lockout verification
- ▶ Store more padlocks and conduct more lockouts within a limited space with this small footprint, large capacity box
- ▶ S3650 comes with 1 lock box and 1 mounting bracket

Master Lock Model #	Description	Dimensions H x L x W
S3650	Group Lock Box with Wall Mounting Bracket	6-7/8in x 3-15/16in x 8-3/8in
PKG57337	Mounting bracket	3.2in x 0.43in x 7.5in

Group Lock Boxes

Made to withstand the toughest environments. Rugged construction offers enhanced design features, making these lock boxes stronger and easier to use.



▶ Control Room ▶ Machine Side ▶ Outdoors ▶ Portable

Rewritable Tag
provides area to write temporary permit-to-work information

Carrying Handle
for portable convenience and easy transportation of locks to energy isolation points

430-Grade Stainless Steel
with heavy-duty powder coat for durability and corrosion resistance

Front Latch
secures door during transit

15-Lock Internal Storage Capacity
for small to medium lockouts

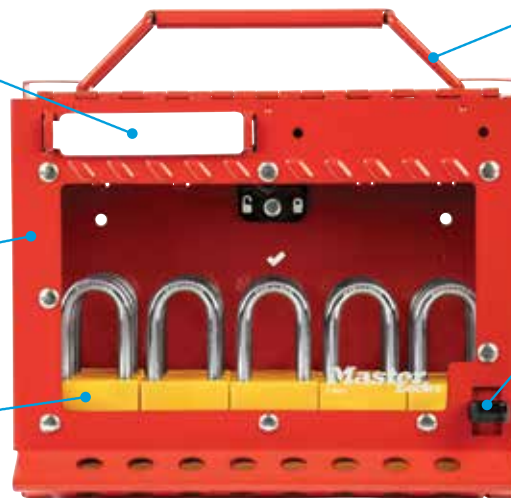

Wall Bracket*
enables easy mounting and redeployment of the lock box

Internal Locking Mechanism allows for optional locking of box to bracket

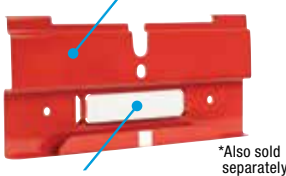

Rewritable Tag*
can be labeled to match box for identification purposes

*Also sold separately

Stamped Checkmark
inside provides visual confirmation of positive attachment when using wall mounting bracket

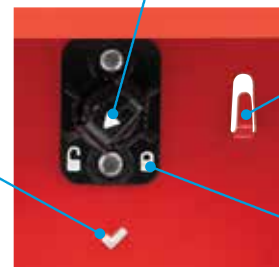

4 Key Hooks
inside display equipment keys individually and keep key numbers visible

Icons
give immediate indication of locked/unlocked status

Group Lock Boxes with Key Window

Heavy-Duty Group Lock Boxes with Key Window that Offer Visual Verification of Secured Keys During Group Lockout

- ▶ Constructed out of 430-grade stainless steel to withstand the toughest environments
- ▶ Each lock box includes a removable cup that creates a clear, impact-resistant window on the front, allowing participants to see keys are secured inside the box during a group lockout
- ▶ All models include 19 total lockout holes, including one on the front latch for the operations lock
- ▶ Models S600 and S601 feature a side window, offering visibility to unused locks
- ▶ The stackable design facilitates storage and simplifies transporting multiple boxes
- ▶ Replacement removable key cups are available

Master Lock Model #	Description	Dimensions H x L x W
S600	Small group lock box	5-13/32in x 9-11/16in x 4-7/8in
S601	Small group lock box with side window for viewing unused locks	
S602	Large group lock box with rewritable label	7-49/64in x 9-11/16in x 4-7/8in



Group Lockout Customization Services Available

- ▶ Master Lock builds group lockout kits containing lock boxes and padlocks configured to customer specifications
- ▶ Group lockout kits increase the efficiency of deploying products on site
- ▶ Contact your Master Lock safety sales representative for more information about our customization and kitting capabilities

Latch Tight™ Group Lock Boxes

Storage Devices Capture Keys for Effective Lockout of Large Equipment

- ▶ Secure each lockout point on a piece of equipment with a single padlock. Place the keys in the group lock box and then each authorized employee places their personal padlock on the lock box
- ▶ When work is complete, employees take their personal padlocks off the lock box, freeing the keys inside. Keys inside cannot be accessed until the last employee removes their padlock
- ▶ Feature an exclusive, patented Latch Tight™ locking mechanism that prevents keys from being accessed until the last padlock or lockout hasp is removed from the box. Provides the highest level of security available in a group lock box
- ▶ Lockout message on box is in three languages – English, Spanish and French
- ▶ Cold-rolled steel with durable powder-coated finish and stainless steel handle

498A

- ▶ Portable solution
- ▶ Available in Red
- ▶ Accepts 12 padlocks or lockout hasps
- ▶ Secures multiple keys

503RED/503YLW

- ▶ Can be mounted to wall or carried from job to job
- ▶ Accepts 14 padlocks or lockout hasps
- ▶ Secures multiple keys
- ▶ Includes organized storage for 12 keys in back of box



Master Lock Model #	Description	Dimensions H x L x W
498A	Portable group lock box	6in x 9-1/4in x 3-3/4in
503RED	Dual application group lock box - Red	12-3/4in x 3-1/2in x 6-3/8in
503YLW	Dual application group lock box - Yellow	12-3/4in x 3-1/2in x 6-3/8in

Modular Permit Control Station

A single location to display and protect paperwork and padlocks for group lockout

- ▶ 430-grade stainless steel with heavy-duty powder coating withstands outdoor elements and provides corrosion resistance
- ▶ Wall mounted for accessibility or use on-the-go for convenience
- ▶ Clear, impact-resistant windows for viewing permit and key(s) during lockout
- ▶ Rubber seal on permit display case protects documents from water damage in outdoor applications or during cleaning
- ▶ Group lock box has 12 numbered lock holes for personal safety locks, plus a latch hole designated for the control lock
- ▶ Includes removable lock caddy for easy transportation of equipment locks to isolation points during lockout

Product Number	Description
S3500	Permit Control Station (Includes S3501 and S3502)
S3501	Permit Display Case
S3502	Wall Mount Group Lock Box

Permit Control Station

Place group lockout where you need it to effectively communicate the status and details of permit-to-work jobs.



S3500



S3500



S3501



S3502





S3924

Blind Flange & Pneumatic Lockouts

Best-in-class lockout solution for pipeline maintenance and innovative ways to lock out virtually any pneumatic fitting.

Blind Flange Lockout

Device provides a physical barrier preventing unwanted blind removal during pipeline maintenance

- ▶ Ideal solution for protecting workers from hazards during pipeline maintenance
- ▶ Device fully conceals flange bolts preventing access to the blind until all work has been completed
- ▶ Easy-to-use, adjustable device provides a tight fit, adapting to multiple flanged pipe applications
- ▶ Three models designed to cover and lock out flange nuts ranging from 3/4in (19mm) to 2-3/4in (69.9mm) diameter and flange widths ranging from 1-1/2in (38.1mm) to 17-7/8in (447.8mm)
- ▶ Durable powder coated aluminum and hardened steel slide bar withstand conditions indoors and out
- ▶ Trilingual, write-on "Danger" labels provided for additional safety ID

Size Chart

Master Lock Model #	Pipe Diameter Range	Nut Diameter	Flange Width Range
S3922	1/2in – 3in (12.7mm – 76.2mm)	3/4in – 1-1/8in (19mm – 28.7mm)	1-1/2in – 5-5/8in (38.1mm – 143.3mm)
S3923	3-1/2in – 12in (88.9mm – 304.8mm)	1in – 1-7/8in (33.3mm – 47.8mm)	3-3/4in – 10-3/4in (95.3mm – 274.6mm)
S3924	14in – 24in (355.6mm – 609.6mm)	2in – 2-3/4in (52.3mm – 69.9mm)	7-3/4in – 17-7/8in (196.9mm – 447.8mm)



S3922
Blind Flange Lockout,
Small

S3923
Blind Flange Lockout,
Medium

S3924
Blind Flange Lockout,
Large

Pneumatic Lockout

Prevents Pneumatic Fitting From Being Connected to Pressurized Air Source

- ▶ Fits virtually all male pneumatic fittings
- ▶ Stainless steel construction for corrosion resistance
- ▶ Measures 1-3/8in wide x 7-3/4in tall x 1/8in thick
- ▶ Accepts any Master Lock or American Lock Safety Padlock with shackle diameter up to 9/32in
- ▶ Works with lockout hasps for multiple worker lockout
- ▶ Accommodates 1/4in, 5/16in, 3/8in, 7/16in, 1/2in, 9/16in, 5/8in, 13/16in connections



S3900

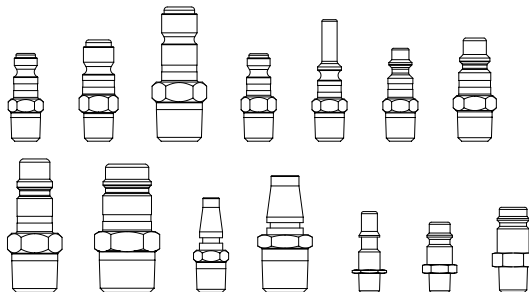

Master Lock Model #	Description
S3900	Stainless Steel Pneumatic Lockout

Removable and Permanent Push Button and Rotary Switch Covers

Temporarily prohibit access or avoid the nuisance of changing rotary switch settings with these durable, versatile, push button & switch covers. Available in both removable and installed versions, covers feature a clear base and cover to allow visibility of nameplates, labels or rotary switch knobs.

- ▶ Fits both 30.5mm and 22.5mm diameter switches

S2151 Removable Push Button and Rotary Switch Cover

- ▶ Accommodates buttons up to 2in (50mm) diameter and 1-3/4in (45mm) tall
- ▶ Includes one cover, one install base and one retrofit base with double-faced adhesive tape
- ▶ S2152AST pack of 12 install bases allows one S2151 to service multiple switches on same panel



S2153 Permanent/Installed Push Button and Rotary Switch Cover

- ▶ Captured by the rotary or pushbutton switch bezel
- ▶ Accommodates buttons up to 1-9/16in (40mm) diameter and 1-3/4in (45mm) tall



S2152AST Install Bases

- ▶ Use with S2151
- ▶ Pack of 12 install bases
- ▶ Allows one S2151 removable cover to service multiple switches on same panel



S2154AST Retrofit Install Bases

- ▶ Use with S2151
- ▶ Pack of 12 horse-shoe shaped retrofit bases with double-faced adhesive tape
- ▶ Allows for use with raised nameplates and off-center installation to accommodate rotary switch knobs



Master Lock Model #	Description
S2151	Removable Button and Switch Cover
S2153	Installed Button and Switch Cover
S2152AST	Install Bases for S2151 Removable Cover (12 pk.)
S2154AST	Retrofit Install Bases for S2151 Removable Cover (12 pk.)



S2152AST



S2154AST

Electrical Covers

Versatile, durable designs address need for temporarily prohibiting access to a switch or control or to avoid nuisance changing of rotary switch settings.

Universal Wall Switch Cover

Locks Out Both Toggle and Decora® Paddle Wall Switches

- ▶ Patented design assures switch is kept on or off
- ▶ Hinges open for unobstructed normal operation of switch
- ▶ Includes English/Spanish and English/French labels



Patented Innovative Design



Master Lock Model #	Description
496B	Universal Wall Switch Cover

Hoist Cover

Effectively Covers Hoist Controls

- ▶ The cinch sack offers broad application solutions
- ▶ Insert PVC tubing (not available through Master Lock) to block access to hoist control buttons
- ▶ Flexible & durable rip-stop nylon bag fits easily in safety tool boxes
- ▶ Lock out with up to 6 padlocks or hasps

Master Lock Model #	Description	Dimensions
453L	Large Nylon Oversized Plug & Control Cover	7in dia. x 17in tall
453XL	Extra Large Nylon Oversized Plug & Control Cover	10in dia. x 26in tall



453L



Hoist Control Cover

Compact Lockout Pouches

Electrical Padlocks and Devices Stored for Convenience

- ▶ Compact, convenient design
- ▶ Velcro straps on back allow pouch to be easily applied to or removed from a belt
- ▶ Straps also serve as breakaway feature in the event the pouch is caught in machinery, protecting the employee

Master Lock Model #		Description
410RED Zenex™ Thermoplastic Padlock(s)	Unfilled	
S1010E410	S1010	Electrical Lockout Focus. Contains: 1 – Padlock; 1 – 7C5RED Breaker Switch Padlock; 1 – 420 Hasp; 2 – 493B, 1 – 491B Circuit Breaker Lockouts; 1 – 497A Tags (12 pk.).

Lockout Kits

The Master Lock Lockout Kits combine and organize commonly used electrical and valve lockout devices for individuals or groups of workers.



S1010E410

Personal Lockout Pouches

Padlocks and Devices for Individual Workers

- ▶ Zippered pouch is easy to carry or wear with adjustable waist strap
- ▶ Two standard assortment kits available, one designed with an electrical lockout focus, the other for general maintenance
- ▶ Personal Lockout Pouches are for an individual worker; padlocks are supplied keyed-alike for added worker convenience

Master Lock Model #		Description
410RED Zenex™ Thermoplastic Padlock(s)	Unfilled	
1456E410	1456	Electrical Lockout Focus. Contains: 1 – Padlock; 1 – 7C5RED Breaker Switch Padlock; 1 – 420 Hasp; 2 pcs – 493B, 1 pc – 491B Circuit Breaker Lockouts; 1 – 497A Tags (12 pk.)
1456P410KA		Padlocks & Tags. Contains: 3 – Padlocks Keyed Alike; 1 – 420 Hasp; 1 – 497A Tags (12 pk.)



1456E410

THE RIGHT PADLOCKS FOR YOUR NEEDS.



Zenex™ Thermoplastic Padlocks

Non-conductive, lightweight bodies with permanent write-on labels for worker identification. Key retaining feature ensures that padlocks are not left unlocked. Reserved-for-Safety, high security, 6-pin cylinder offers over 100,000 possible key changes.



Personal Ultra-Durable Lockout Kits

Electrical, Valve and Combined Lockout/Tagout Toolboxes

- ▶ Upgraded safety lockout toolbox keeps important lockout devices and padlocks together
- ▶ Kits include high-use components, satisfying most lockout applications
- ▶ Personal kits are for an individual worker; padlocks are supplied **keyed-alike** for added worker convenience

Master Lock Model #		Description
410RED Zenex™ Thermoplastic Padlock(s)	Unfilled	
1457E410KA	S1017*	Electrical Lockout Focus. Contains: 3 – Padlocks; 1 – 7C5RED Circuit Breaker Padlock; 1 – 420 Hasp; 1 – 427 Snap-On Hasp; 2 – 491B, 3 – 493B Circuit Breaker Lockouts; 1 – 496B Wall Switch Cover; 1 – 497A Tags (12 pk.)
1457V410KA		Valve Lockout Focus. Contains: 3 Padlocks; 1 – 420 Hasp; 1 – 427 Snap-On Hasp; 1 – S806 Adjustable Cable Lockout; 1 – 480, 1 – 481 & 1 – 482 Gate Valve Covers; 1 – 468L & 1 – S3068 Ball Valve Lockouts; 1 – 497A Tags (12 pk.)
1457VE410KA		Electrical & Valve Lockout Focus. Contains: 3 – Padlocks; 1 – 7C5RED Circuit Breaker Padlock; 1 – 420 Hasp; 1 – 427 Snap-On Hasp; 1 – S806 Adjustable Cable Lockout; 1 – 480, 1 – 481 & 1 – 482 Gate Valve Covers; 1 – 468L & 1 – S3068 Ball Valve Lockouts; 2 – 491B, 3 – 493B Circuit Breaker Lockouts; 1 – 496B Wall Switch Cover; 1 – 497A Tags (12 pk.)



*Unfilled toolboxes also available in 23in (S1023)

Group Lockout Kits

Modular Lockout/Tagout Organizers

- ▶ Lightweight safety lockout carrying case, 15in W x 9-1/2in T x 7in D, with modular, translucent storage compartments for improved organization and fast component selection
- ▶ Kits include high-use components, satisfying most applications
- ▶ Separate compartments for effective grouping of (1) padlocks & hasps, (2) valve lockout & (3) electrical lockout components
- ▶ Group kits are for multiple workers; padlocks are supplied **keyed-different**, so that no unwanted key interchange occurs
- ▶ **LifeGuard™** safety padlock key charting system available at no charge. Visit www.masterlock.com for details

Master Lock Model #		Description
410RED Zenex™ Thermoplastic Padlock(s)	Unfilled	
1458E410	1458	Electrical Lockout Focus. Contains: 6 – Padlocks; 2 – 7C5RED Breaker Switch Padlocks; 1 – 420 Hasp; 1 – 427 Snap-On Hasp; 1 – S806 Adjustable Cable Lockout; 1 – 487 & 1 – 488 Plug Covers; 4 pcs – 493B, 2 pcs – 491B Circuit Breaker Lockouts; 2 pcs – 496B Wall Switch Covers; 2 – 497A Tags (12 pk.)
1458V410		Valve Lockout Focus. Contains: 6 – Padlocks; 1 – 420 Hasp; 1 – 427 Snap-On Hasp; 1 – S806 Adjustable Cable Lockout; 1 – 480, 1 – 481, 1 – 482 & 1 – 483 Gate Valve Covers; 1 – 468L & 1 – S3068 Ball Valve Lockouts; 2 – 497A Tags (12 pk.)
1458VE410		Electrical & Valve Lockout Focus. Contains: 6 – Padlocks; 2 – 7C5RED Breaker Switch Padlocks; 1 – 420 Hasp; 1 – 427 Snap-On Hasp; 1 – S806 Adjustable Cable Lockout; 1 – 487 & 1 – 488 Plug Covers; 1 – 480, 1 – 481 & 1 – 482 Gate Valve Covers; 6 – 493B, 3 pcs – 491B Circuit Breaker Lockouts; 2 – 496B Wall Switch Covers; 1 – 468L & 1 – S3068 Ball Valve Lockouts; 2 – 497A Tags (12 pk.)



* Provided that your Registered System Number is included on all future orders.



1483BP410

Padlock Stations

Durable stations for the protection of, and easy access to, padlocks

- ▶ Integrated, one-piece molded construction eliminates loose parts
- ▶ Exclusive translucent cover protects contents
 - Lockable to prevent loss of valuable safety lockout padlocks. Recommend using a combination lock for simple access control
 - Innovative hinge holds cover open for easy product selection
- ▶ Available with your choice of Zenex™ Thermoplastic, Aluminum padlocks in 4, 10 or 20 lock formats
- ▶ Safety Hasps and Tags included
- ▶ **LifeGuard™** safety padlock key charting system available at no charge. Visit www.masterlock.com for details

Padlock Stations

These durable, user-friendly stations provide a central location for lockout padlocks, tags and hasps.



1482BP410



1484BP1106FRC

(175 Padlock available separately)

Master Lock Model #			Description	Size (H x W x D)
410RED Zenex™ Thermoplastic Padlock(s)	A1106RED Aluminum Padlock(s)	Base and Cover (Unfilled)		
1482BP410	1482BP1106	1482B	4-Lock Station. Contains 4 – Padlocks; 2 – 420 Hasps; 1 – 497A Tags (12 pk.)	12-1/4 x 16 x 1-3/4
1483BP410	1483BP1106	1483B	10-Lock Station. Contains 10 – Padlocks; 2 – 420 Hasps; 2 – 497A Tags (12 pk.)	15-1/2 x 22 x 1-3/4
1484BP410	1484BP1106	1484B	20-Lock Station. Contains 20 – Padlocks; 4 – 420 Hasps; 4 – 497A Tags (12 pk.)	22 x 22 x 1-3/4
English/Spanish Stations				
1482BP410ES	1482BP1106ES	1482BES	4-Lock Station. Contains 4 – Padlocks; 2 – 420 Hasps; 1 – 497AX Tags (12 pk.)	12-1/4 x 16 x 1-3/4
1483BP410ES	1483BP1106ES	1483BES	10-Lock Station. Contains 10 – Padlocks; 2 – 420 Hasps; 2 – 497AX Tags (12 pk.)	15-1/2 x 22 x 1-3/4
1484BP410ES	1484BP1106ES	1484BES	20-Lock Station. Contains 20 – Padlocks; 4 – 420 Hasps; 4 – 497AX Tags (12 pk.)	22 x 22 x 1-3/4
English/French Stations				
1482BP410FRC	1482BP1106FRC	1482BFRC	4-Lock Station. Contains 4 – Padlocks; 2 – 420 Hasps; 1 – 497ABLC Tags (12 pk.)	12-1/4 x 16 x 1-3/4
1483BP410FRC	1483BP1106FRC	1483BFRC	10-Lock Station. Contains 10 – Padlocks; 2 – 420 Hasps; 2 – 497ABLC Tags (12 pk.)	15-1/2 x 22 x 1-3/4
1484BP410FRC	1484BP1106FRC	1484BFRC	20-Lock Station. Contains 20 – Padlocks; 4 – 420 Hasps; 4 – 497ABLC Tags (12 pk.)	22 x 22 x 1-3/4

*Provided that your Registered System Number is included on all future orders.

CHOOSE THE PADLOCKS FOR YOUR NEEDS.

Master Lock

Zenex™ Thermoplastic Padlocks

Non-conductive, lightweight bodies with permanent write-on labels for worker identification. Key retaining feature ensures that padlocks are not left unlocked. Reserved-for-Safety, high security, 6-pin cylinder offers over 100,000 possible key changes.



AMERICAN LOCK

Anodized Aluminum Padlocks

Heavy duty padlocks feature a durable anodized finish. The 5-pin cylinder offers over 10,000 key changes to minimize risk of key number duplication within a facility.





S1745E410

Heavy-Duty Padlock Racks

- ▶ Heavy gauge steel with durable powder coat finish to ensure long life
- ▶ Includes labels in English, Spanish/English, and French/English

Master Lock Model #	Description
S1506	6.25in wide x 3in tall x 1.5in deep. Holds 6-8 padlocks
S1518	17.5in wide x 3in tall x 1.5in deep. Holds 18-22 padlocks



S1506



S1518



Compact Stations

Our padlock racks and lockout stations are ideal for positioning machine-specific lockout devices, tags and padlocks near the lockout point.

Compact Lockout Stations

Compact Lockout Station Holds Machine Specific Lockout Devices and Padlocks Near Lockout Point

- ▶ Durable construction for years of use in corrosive environments
- ▶ 4 hanger clips for safety padlocks or hasps
- ▶ Includes face labels in English, Spanish/English or French/English
- ▶ Available filled or unfilled
- ▶ Filled centers available with Zenex™ Thermoplastic Safety Padlocks
- ▶ Measures 9-3/4in tall x 7-3/4in wide x 3-3/8in deep
- ▶ Bin measures 6-1/2in wide x 2-7/8in tall x 2-7/8in deep



S1745E410

Master Lock Model #		Description
410RED Zenex™ Thermoplastic Padlock(s)	(Unfilled)	
S1705P410	S1700	Contains: 1 – Padlock, 1 – 421 Hasp and 2 – Tags
S1720E410	S1700	Contains: 2 – Padlocks, 4 – Tags, 2 – 491B and 2 – 493B Circuit Breaker Lockouts
S1745E410	S1700	Contains: 1 – Padlock, 1 – 488 Plug Lockout, and 1 – Tag

S1700



S1705P410



S1720E410
(Hasps available separately)



Deluxe Lockout Station

Large Capacity Lockout Station Holds Departmental Lockout Needs

- ▶ Durable construction ensures long life in your facility
- ▶ Upper and lower sections lockable to ensure devices are there when needed for lockout. Add a combination lock for simple access control
- ▶ 16 hanger clips hold 2 padlocks or lockout hasps each
- ▶ Covered compartments protect devices and keep dust and grime out
- ▶ Moveable dividers in top and bottom trays help organize devices
- ▶ Holes provided along bottom for optional peg hook hangers. Use to hang large, bulky devices
- ▶ Available filled or unfilled
- ▶ Upper unit ideal for larger lockout devices and padlocks. Lower unit ideal for tags and smaller lockout devices
- ▶ Lower unit has two tip-out drawers. Each measures 10in wide x 6-7/8in high x 3-1/4in deep
 - Dividers included to create 2, 3, 4, 5 or 6 compartments
 - Each compartment holds 25 tags. Total capacity of lower unit is 150 tags
- ▶ Measures 26-1/2in high x 22in wide x 4-1/8in deep
- ▶ **LifeGuard™** safety padlock key charting system available at no charge. See page 5 for details

Master Lock Model #		Description
410RED Zenex™ Thermoplastic Padlock(s)	(Unfilled)	
S1900VE410	S1900	Contains: 6 – Padlocks; 2 – 420 Hasps; 1 – 427 Snap-On Hasp; 1 – S806 Adjustable Cable Lockout; 1 – 480, 1 – 481, 1 – 482 & 1 – 483 Gate Valve Lockouts; 1 – 468L & 1 – S3068 Ball Valve Lockouts; 1 – S2005 Compact Plug Prong Lockout; 1 – 488 Plug Cover; 2 – 491B, 6 – 493B Circuit Breaker Lockouts; 2 pcs – 496B Wall Switch Covers; 2 – 497A Tags (12 pk.). Space for additional padlocks or lockout devices as desired
Bilingual Stations		
S1900VE410ES	S1900ES	English/Spanish Station: Standard VE Assortment; 2 – 497AX English/Spanish Tags replace 497A's
S1900VE410FRC	S1900FRC	English/French Station: Standard VE Assortment; 2 – 497BLC English/French Tags replace 497A's

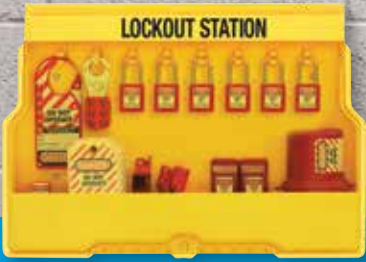

S1850E410

Lockout Stations

These durable, user-friendly wall stations offer the ultimate storage space for large facilities or multiple departmental use.

CHOOSE THE PADLOCKS FOR YOUR NEEDS.

Master Lock

Zenex™ Thermoplastic Padlocks

Non-conductive, lightweight bodies with permanent write-on labels for worker identification. Key retaining feature ensures that padlocks are not left unlocked. Reserved-for-Safety, high security, 6-pin cylinder offers over 100,000 possible key changes.



AMERICAN LOCK

Anodized Aluminum Padlocks

Heavy duty padlocks feature a durable anodized finish. The 5-pin cylinder offers over 10,000 key changes to minimize risk of key number duplication within a facility.



S1900VE410

Lockable Covers



Adjustable Dividers



Additional Storage on Top



Lockout Station

Lockout Station Holds Locks, Hasps and Devices

- ▶ Durable construction for years of use in corrosive environments
- ▶ Top and bottom compartments each have 5 moveable dividers for organizing devices
- ▶ 8 hanger clips hold 2 padlocks or lockout hasps each
- ▶ Holes provided inside and along bottom for optional peghook hanger clips. Allows you to organize further. Large devices can be hung below
- ▶ Cover protects padlocks and devices from dust and grime
- ▶ Lockable. Use combination padlock to limit access to authorized employees
- ▶ Measures 15-1/2in high x 22in wide x 4-1/8in deep
- ▶ Available with Electrical or Valve Lockout Focus. Includes most commonly required lockout devices
- ▶ Available filled or unfilled
- ▶ **LifeGuard™** safety padlock key charting system available at no charge. See page 5 for details

Master Lock Model #			Description
410RED Zenex™ Thermoplastic Padlock(s)	A1106RED Aluminum Padlock(s)	(Unfilled)	
S1850E410	S1850E1106	S1850	Electrical Lockout Focus. Contains: 6 – Padlocks; 1 – 420 Hasp; 1 – 427 Snap-On Hasp; 1 – S2005 Compact Plug Prong Lockout; 1 – 488 Plug Cover; 2 – 491B, 4 – 493B Circuit Breaker Lockouts; 2 – 496B Wall Switch Covers; 2 – 497A Tags (12 pk.)
S1850E410ES	S1850E1106ES	S1850ES	English/Spanish Station; S1850 Electrical Assortment – English/Spanish 497AX Tags replace 497A's
S1850E410FRC	S1850E1106FRC	S1850FRC	English/French Station; S1850 Electrical Assortment – English/French 497ABLC Tags replace 497A's



S1850 (Unfilled)



S1850E410ES

Deluxe Tag Center

Deluxe Tag/Lockout Center Holds Multiple Groups of Tags

- ▶ Durable construction for years of use in corrosive environments
- ▶ Two tip-out drawers with dividers to create 2, 3, 4, 5 or 6 compartments
- ▶ 8 hanger clips along bottom hold safety padlocks or hasps
- ▶ Each compartment holds 25 tags. 150 tag capacity
- ▶ Compartments can be used for lockout devices too
- ▶ Each tip-out drawer measures 10in wide x 6-7/8in tall x 3-1/4in deep inside
- ▶ Upper tray for zip ties and small lockout devices
- ▶ Lockable. Use combination padlock to limit access to authorized employees
- ▶ Also suitable for ear plugs and eyewear



S1800

Master Lock Model #	Description	Dimensions (H x W x D)
S1800	Tag Center (unfilled)	11in x 22in x 4-1/8in

“DO NOT OPERATE” Safety Tags

Laminated Tags Comply with OSHA Lockout/Tagout Standard

- ▶ Durable polyester laminate resists water, grease and extreme temperatures
- ▶ Heavy duty construction withstands over 50 lbs. of pull force (meets OSHA requirement); prevents accidental removal
- ▶ Write-on name, department, expected completion
- ▶ 7/16in dia. brass grommet accepts all safety padlocks
- ▶ Single language and bilingual tag options
- ▶ Tags available in other languages; call for details



Master Lock Model #	Description	Dimensions (H x W)
497A	English, 1 bag of 12 tags with ties	5-3/4in x 3-1/8in
497AX	Spanish/English 1 bag of 12 tags with ties	5-3/4in x 3-1/8in
497ABLC	French/English 1 bag of 12 tags with ties	5-3/4in x 3-1/8in

“DO NOT OPERATE” Self Laminating Photo ID Safety Tags

Provides a Visual Representation of the Affected Employee

- ▶ Durable Polypropylene with PVC laminate overlay resists water, grease, extreme temperatures, and common industrial chemicals
- ▶ Heavy duty construction withstands over 50 lbs. of pull force (meets OSHA requirement); prevents accidental removal
- ▶ 3/8in diameter brass grommet accepts all safety padlocks and hasps
- ▶ Customize with name, department, and employee specific photo ID
- ▶ Single language and bilingual tag options



Master Lock Model #	Description	Dimensions (H x W)
S4800LEN	English with European Danger Symbol, 1 bag of 12 tags with ties	5-4/5in x 3-1/5in
S4800LES	Spanish with European Danger Symbol, 1 bag of 12 tags with ties	
S4801	English, 1 bag of 12 tags with ties	
S4802LEN	English with U.K. Prohibition Symbol, 1 bag of 12 tags with ties	



Safety Tags

Identification tags are key components to any safety lockout program. Master Lock offers write-on tags in English, Spanish and French to accommodate employee needs.



497A

“DO NOT OPERATE” Roll of Tags

Roll of disposable Safety tags stored in portable box for convenience

- ▶ Roll of tags in portable dispenser box makes organization and transportation easy – Box dimensions: 7-7/8in x 4-1/4in x 4-1/4in (200mm x 108mm x 108mm)
- ▶ 3/8in (9.5mm) diameter reinforced opening to accept all safety padlock shackles
- ▶ 6in x 3in (152mm x 76mm) tag with “DO NOT OPERATE” message
- ▶ Made of durable polypropylene material for chemical resistance
- ▶ Can be marked with pencil, pen, and permanent marker
- ▶ Available in 4 languages – English, Spanish, French, and Portuguese



S4810



S4810LES



S4810LFR



Master Lock Model #	Description	Dimensions (H x W)
S4810	English, 1 roll of 100 tags	6in x 3in
S4810LES	Spanish, 1 roll of 100 tags	
S4810LFR	French with European Danger Symbol, 1 roll of 100 tags	
S4810LPT	Portuguese, 1 roll of 100 tags	
S4810LENUK	English with European Danger Symbol, 1 roll of 100 tags	



S4810LPT



S4810LENUK

Maintenance Lockout Tags

Disposable Safety tags for temporary lockout

- ▶ Compact size allows for application in virtually any area
- ▶ Durable laminated material withstands extreme environments
- ▶ Attach with your personal padlock - hassle free, no zip tie needed
- ▶ Accepts up to 9/32in (7mm) shackle diameter
- ▶ Can be marked with pencil, pen, and permanent marker
- ▶ Complies with OSHA standards
- ▶ Available in 4 languages – English, Spanish, French, and Portuguese



S297



S297LES



S297LFR



S297LPT

Master Lock Model #	Description	Dimensions (H x W)
S297	English, 1 bag of 100	1-1/4in x 5-1/2in
S297LES	Spanish, 1 bag of 100	
S297LFR	French with European Danger Symbol, 1 bag of 100	
S297LPT	Portuguese, 1 bag of 100	



Guardian Extreme™ Safety Tags

Make sure your safety message is clearly visible for years and years with Guardian Extreme™ tags.

Guardian Extreme™ Safety Tags

Our process permanently fuses the safety message into rugged, industrial grade polypropylene, creating the longest lasting tags available. These graphics remain vibrant and clear for years – even when exposed to high humidity, UV radiation, harsh chemicals, frequent wash downs, extreme high and low temperatures and more.

Metal detectable versions available for use in food processing and pharmaceutical facilities.

Environmentally Friendly is Business Friendly

Guardian Extreme™ lifetime tags and signs withstand tough environments and abuse eliminating the cost of replacement.

Rewrite-Reuse

Modify the message as often as needed

Guardian Extreme™ signs and tags provide the ultimate flexibility. You add the exact safety message for the job with permanent marker, erase it when the work is complete and repurpose it for the next job.



Wipe off current message with Isopropyl Alcohol



Cleaned tag ready for next message - write new message with permanent marker



A brand new message is ready for the next project

Guardian Extreme™ Safety Tags 3in x 5-3/4in (Bag of 6)



S4002



S4002MT
(Metal Detectable)



S4046
(Red)



S4050
(Yellow)



S4060
(Yellow)

Safety Lockout Planograms

Four planograms are organized to focus on different types of lockout – electrical lockout, plumbing lockout and general lockout



Safety Lockout Planograms

Assortments of safety padlocks, lockout devices, tags and kits suited for a variety of lockout requirements.



Master Lock Model #	Description	1337LGENIND	1337SMGENIND	1336ELECT	1336PLMB
S1010DELECKIT	Electrical Lockout Kit	X		X	
S1010DGCKIT	General Contractor Lockout Kit	X	X		
497AD	Lockout Identification Tags	X	X	X	X
410TRIRED	Keyed-Alike Set of 3 Zenex™ Thermoplastic Safety Padlocks	X		X	X
410DRED	Lightweight Zenex™ Thermoplastic Safety Padlock	X	X	X	X
420D	Steel Lockout Hasp	X	X	X	X
S2394D	Miniature Circuit Breaker Lockout	X		X	
506D	Grip Tight™ Circuit Breaker Lockout Set	X	X	X	X
487D	Electrical Plug Lockout	X	X	X	X
496BD	Universal Wall Switch Cover	X		X	
S806D	Adjustable Cable Lockout Device	X	X	X	X
480D	Gate Valve Lockout	X	X		X
S3081D	Adjustable Ball Valve Lockout	X	X		X
1334POGKIT	Merchandising Kit, Header, Product Cards and Schematics	X	X	X	X

Planograms include two of each item, a Master Lock header and a set of re-order tags.

All of the carded safety padlocks, devices and tags listed are available for purchase separately to replenish or expand your planogram and enhance your showroom. Carded commercial security products and commercial security planograms are also available.



Professional Lockout Services

Master Lock Professional Lockout Services can take a holistic approach to build a customized, best-in-class lockout management system or focus on the select elements that will make significant improvements in a facility's safety program

Professional Lockout Services

Expert guidance and industry-leading experience to help facilities meet safety goals.



Assessment

Our safety experts conduct in-depth, on-site assessments to evaluate the current state of a lockout tagout program and identify methods of improvement. The recommendations from the assessment can be used to design a best-in-class lockout/tagout program that achieves heightened safety, practicality and efficiency for personnel.



Written Program

A team of safety consultants will develop a company-wide written lockout program that takes an efficient approach to meet and exceed compliance requirements.



Written Procedures

Our technicians complete an in-depth analysis of equipment and energy sources to create detailed lockout isolation procedures.



Tiered Training

We empower organizations to create a safer work environment. Achieving a compliant lockout management system requires ongoing training. Our safety certified staff will come on-site and lead all or any of the hands-on courses requested. We offer the following training courses:

- Authorized Personnel
- Affected Personnel
- Lockout Procedure Creation
- Lockout Practitioner Workshop
- Lockout Leadership



Proper Equipment

Our safety experts can provide recommendations on the necessary safety padlocks, lockout devices, and identification tags for a best-in-class lockout management system.



Access

Experience has shown it should take less than 15 seconds to access lockout equipment. Keeping the necessary equipment close and easily accessible by authorized personnel saves time, eliminates excuses, and helps prevent damages and injuries.



Audits

Our safety experts offer on-site review of lockout procedures and programs to help ensure compliance requirements are met. We deliver a summary report which includes best-practice recommendations and corrective actions.

Estimates for services will be provided once the scope of work has been identified.

For more information about Master Lock Professional Lockout Services, speak with a Master Lock Sales Representative or visit www.masterlock.com/PLOS.



Master Lock eLOTO Lockout Procedure Writing Software

Empower employees with the tools needed to make work environments safer

Master Lock eLOTO is an easy-to-use, cloud-based software solution for writing and managing visual lockout procedures. Master Lock eLOTO is comprised of a web interface and two mobile applications:

Lockout Procedure Writing Software

Machine-specific procedures are a requirement of a compliant lockout management system. Master Lock eLOTO provides a best-practice solution to create visual lockout procedures and conduct audits.



eLOTO Writer App

- ▶ Collect data right at the machine for each lockout isolation point



eLOTO Procedure Database

- ▶ Use a web browser to create, modify and print lockout procedures, and manage dates and tasks associated with audits



eLOTO Inspector App

- ▶ Audit procedures and authorized personnel at the equipment location

The eLOTO procedure database and the Writer and Inspector mobile applications work together to help ensure lockout procedures are accurate and up-to-date. Printed procedures meet the best-practice format demonstrated in ANSI Z244.1-2016.



www.masterlock.com

www.masterlock.com

Master Lock Company LLC, Milwaukee, WI 53154 U.S.A. | 800-308-9244
Master Lock Canada, Mississauga, Ontario L5L 5Z9 Canada | 800-227-9599
© 2019 Master Lock Company | All Rights Reserved.

7000-0193 PDF 11/19

**Master
Lock.**

**AMERICAN
LOCK®**