



# TITAN<sup>®</sup>

## ACCESSORIES





# THE BEST AND LONGEST WARRANTY IN THE INDUSTRY

## **Four-Year Manufacturer's Defect**

We pledge that our sprayers are free from defects in materials and workmanship. This excludes normal wear items and consumables such as filters, piston, packings, tips, etc.

## **Lifetime DuraLife Brushless HE and PMDC Motor Warranty**

If the motor fails for any reason (including wear) for as long as you own the sprayer, we will replace the motor at no cost to you.

## **Limited Lifetime DCX Motor Warranty**

If the motor fails from normal usage for as long as you own the sprayer, we will replace the motor at no cost to you.

## **Gas Engine Warranty**

3-year Honda® and 2-years all others.

## **Two-Year Turbine Warranty**

## **Lifetime Drive Train Warranty**

If the drive train fails from normal usage for as long as you own the sprayer, we will replace the drive train at no cost to you.

## **Lifetime Warranty on PermaStroke™ Technology Fluid Pump**

Get a lifetime warranty on the PermaStroke Technology fluid pump. If the fluid pump fails for any reason (including wear) for as long as you own the sprayer, we will replace the fluid pump at no cost to you.

## **35-Day Satisfaction Guarantee**

If for any reason the sprayer does not perform up to your expectations within 35 days, the sprayer can be exchanged for the identical model or full credit toward the purchase of a Titan sprayer of larger size and value.

## **Express Parts Program**

- ▶ More than 550 Authorized Service Centers nationwide
- ▶ The most common repair parts are guaranteed to be in stock 100% of the time
- ▶ If for any reason your preferred Authorized Service Center is out of stock, free 2nd day air is available when ordered by 3:00 pm (EST)

**SEE BACK PAGE FOR OUR PLATINUM AND ELITE PROGRAMS.**



# TITAN®

## ACCESSORIES

### 04 AIRLESS GUNS

An industry leader in spray gun technology – Titan offers a full line of the best quality airless guns for every application imaginable.

### 07 AIRLESS TIPS

Titan offers a full range of spray tips for a full range of applications.

### 12 GUN ACCESSORIES

Titan has a guard for every tip and the best paint filters available. And if your arms just aren't long enough we have a reach tool or gun extension.

### 16 AIRLESS HOSES

Designed to withstand time and pressure, Titan's full line of airless hoses will have you covered for every job.

### 18 ROLLERS

Our rollers have the speed of a sprayer and the control of a roller.

### 20 FITTINGS

Need more hose length or need to alter the angle of the hose connected to the sprayer? You need Titan manifolds and fittings.

### 22 LINE STRIPING ACCESSORIES

Check out our hard-working assortment of accessories devoted specifically to pavement and turf marking.

### 24 HVLP GUNS & ACCESSORIES

For contractors and finishing professionals who expect flawless results, we have the tools for the perfect finish..

### 27 CLEANERS & LUBRICANTS

Titan has all the products you need to keep your equipment/accessories clean and functioning in top condition.

## OUR MISSION

When your business depends on the tools you use,  
you need to count on the people who make them.

Our relentless commitment to helping all professional painters be  
their best leads to better work, improved ROI and growing business.

# RX-80™

## AIRLESS SPRAY GUN

-  **Comfort Grip™**  
Ergonomic design brings added comfort.
-  **Longer Life Packing Kit**  
Lasts longer with improved performance.
-  **Onboard Tools**  
Smart tools that make jobsite life easier.

- Comes with two or four-finger trigger
- Pressure rated at 3600 PSI (24.8 MPa)

DESCRIPTION	PART NO.
RX-80 Airless Gun, Four-Finger with TR <sup>1</sup>	0538005
RX-80 Airless Gun, Two-Finger with TR <sup>1</sup>	0538006
RX-80 Airless Gun, Four-Finger with SC-6+	0538007
RX-80 Airless Gun, Two-Finger with SC-6+	0538008
RX-80 4-Finger Gun, Hose and Tip Kit with TR <sup>1*</sup>	0538010
RX-80 4-Finger Gun, Hose and Tip Kit w/ SC-6+*	0538011
RX-80 Gun, Hose and Tip Kit (8-pk)	2403960
RX-80 Repair Kit	0538215

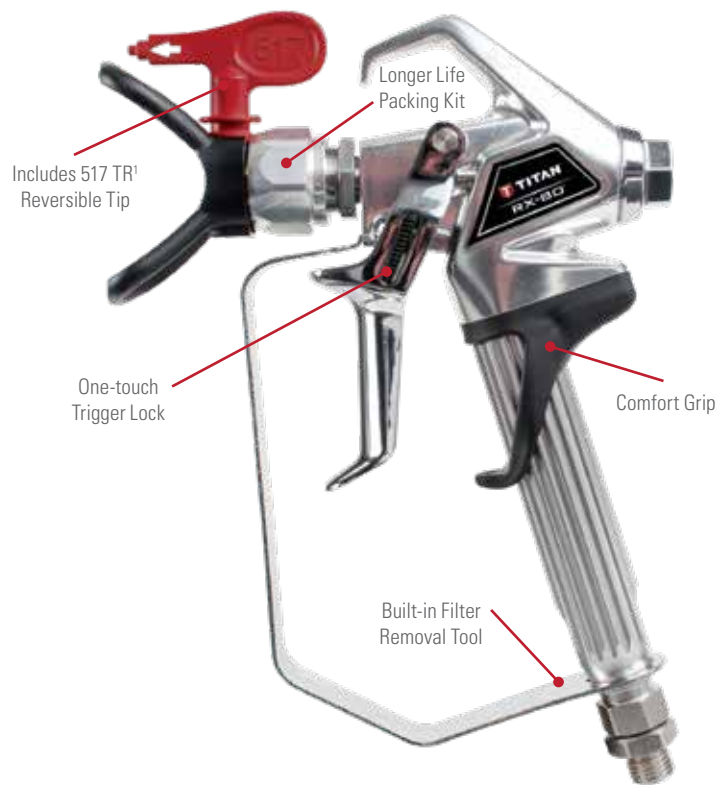

\*Includes additional 3' whip hose and a 2-finger trigger.



Filter Assembly

# RX-PRO®

## AIRLESS SPRAY GUN

-  **Ultra-light Trigger**  
30% lighter than the competitors trigger pull decreasing fatigue.
-  **FingerPrint Grip®**  
Customize the grip to comfortably fit any painter's hand.
-  **Infinity Packing®**  
2X the gun life by reversing the seat and changing the ball.
-  **Onboard Tools**  
Smart tools that make jobsite life easier.

- Comes with both two and four-finger trigger
- Pressure rated at 3600 PSI (24.8 MPa)

DESCRIPTION	PART NO.
RX-Pro Airless Gun with TR <sup>1</sup> Tip	0538020
RX-Pro Gun, Hose, Whip & Tip Kit	0538022
RX-Pro Gun, Hose & Tip Kit (8-pk)	0538030
RX-Pro Gun, Hose, Whip & HEA™ Tip Kit	0538033
RX-Pro Ball Valve	0538221
RX-Pro Seat	594-033
RX-Pro Packing Seal Assy.	0538204A



3 Grip Sizes Available

### FingerPrint Grip

Customizable to your hand size.



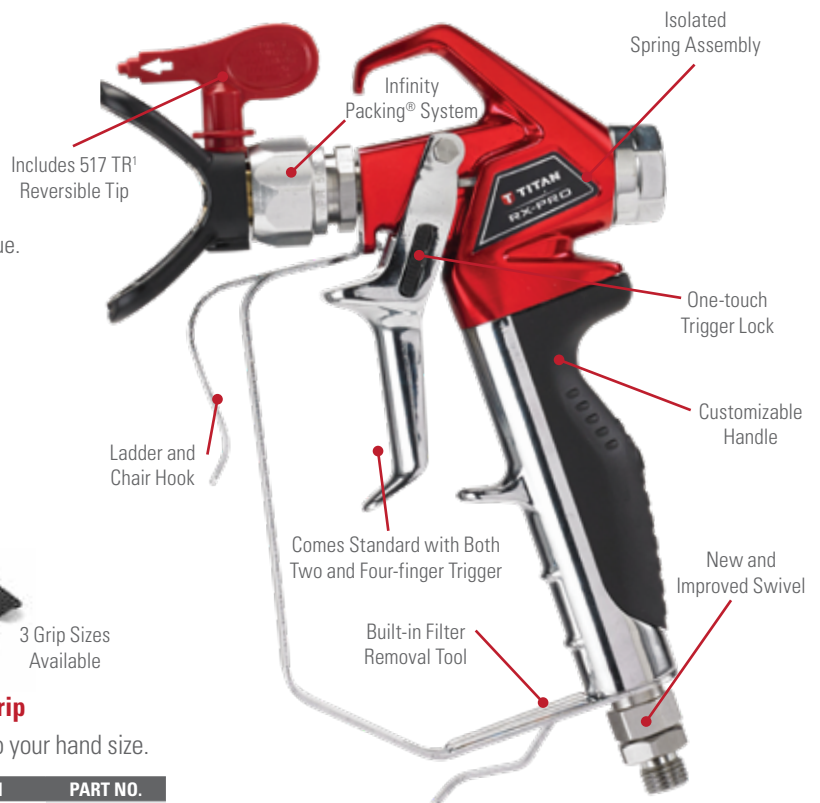

DESCRIPTION	PART NO.
Small	0538217
Medium	0538218
Large	0538219





# RX-APEX

## AIRLESS SPRAY GUN

-  **All-Day Trigger®**  
28% lighter trigger pull force and 74% less hold force.
-  **FingerPrint+ Grip™**  
Fully adjustable grip delivers maximum customization.
-  **Infinity Packing®**  
2X the gun life by reversing the seat and changing the ball.
-  **Free-Flow Swivel**  
Only direct feed airless gun with built-in swivel.

- Comes with two-finger trigger
- Pressure rated at 5000 PSI (34.5 MPa)

DESCRIPTION	PART NO.
RX-Apex, Non-Filtered Airless Gun with TR <sup>1</sup> Tip	0538070
RX-Apex, Filtered Airless Gun with TR <sup>1</sup> Tip	0538075
RX-Apex, Non-Filtered Airless Gun, Hose & TR <sup>1</sup> Tip Kit	0538072
RX-Apex, Non-Filtered, High Pressure Airless Gun, Hose & TR <sup>1</sup> Tip Kit	0538073
RX-Apex, Filtered Airless Gun, Hose & TR <sup>1</sup> Tip Kit	0538076
RX-Apex, Filtered Airless Gun, Hose & TR <sup>1</sup> HEA Tip Kit	0538077



**FingerPrint+ Grip**  
Customizable to your hand size.

DESCRIPTION	PART NO.
Small	0538247
Medium	0538248
Full	0538256

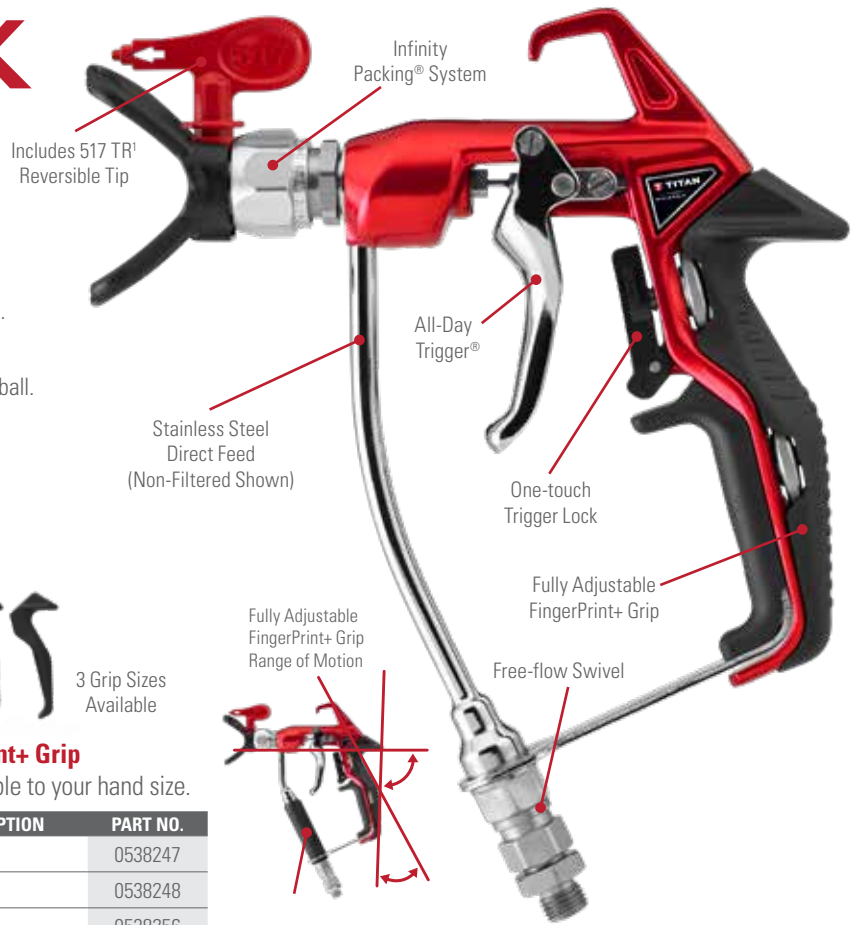

## S-Series: Spray Specialized Coatings with Ease

### S-3 Airless Gun

- In-handle filter
- Easy four-finger trigger pull
- 1/4" swivel reduces hose kinks
- Pressure rated at 3900 PSI (26.9 MPa)



DESCRIPTION	PART NO.
S-3 Gun with TR <sup>1</sup> Tip	0550060
S-3 Gun, Hose and Tip Kit	0550065
S-3 Repair Kit	550-275

### S-7 Airless Gun

- In-handle filter
- Available in two swivel sizes
- Easy four-finger trigger pull
- Swivel reduces hose kinks
- Includes 517 TR<sup>1</sup> high pressure, heavy-duty reversible tip and guard
- Pressure rated at 7700 PSI (53.1 MPa)



DESCRIPTION	PART NO.
S-7 Gun with 1/4" Swivel	550-260
S-7 Gun with 3/8" Swivel	550-270
S-7 Repair Kit	550-276

## Entry Level Contractor Airless Guns

### LX-40 Airless Gun 550-540

- All metal construction
- In-handle filter
- Tungsten carbide ball valve ensures long life
- Includes 517 TR<sup>1</sup> reversible tip
- Pressure rated at 3000 PSI (20.7 MPa)



### LX-50 Airless Gun 0286021

- All metal construction
- In-handle filter
- Tungsten carbide ball valve ensures long life
- Includes 517 TR<sup>1</sup> reversible tip
- Pressure rated at 3000 PSI (20.7 MPa)



# FROM FINE FINISHING TO THE HARSHTEST COATINGS

From the harshest coatings (Mastic Guns) to detailed fine finish work (GM 3600) Titan has a gun that fits your needs.



GM 3600 Gun

M-4 Mastic Gun

## M-4 and M-8 Mastic Guns

- Straight line fluid passage allows max flow rate
- Angled handle for increased comfort
- Adjustable needle packing prolongs the life of critical wear parts
- Swivel allows freedom of movement without hose kinking
- Lightweight metal construction

DESCRIPTION	PSI	PART NO.
M-4 Mastic Gun	3600 (24.8 MPa)	0289013
M-8 Mastic Gun	7700 (53.1 MPa)	0289014
M-4 / M-8 Repair Kit	---	2348175

## GM 3600 Gun

This air-assisted airless gun works with both standard reversible tips and Brilliant™ Flat Tips. It offers ergonomic comfort and a reversible tip system without sacrificing finish quality.

- Inline filter for clean coatings
- Stainless steel fluid passages
- Pressure rated at 3600 PSI (24.8 MPa)

DESCRIPTION	PART NO.
3600 AirCoat Gun with Reversible Tip Guard	0524357
GM 3600 Air Cap Assembly for Reversible Tip	0524359
GM 3600 AirCoat Gun with Flat Tip Guard*	0524358
GM 3600 Air Cap Assembly for Flat Tip	394965
GM 3600 AirCoat Test Air Cap Kit	0524229
GM 3600 AirCoat Gun, 50' Hose and Reversible Tip Kit	524219
GM 3600 AirCoat Gun, 50' Hose and Flat Tip Kit	524220

\*Includes 9/20 Flat Tip.

BRILLIANT™ FLAT TIP SIZES (For GM 3600 Gun)				
DESIGNATION	ORIFICE DIAMETER	ANGLE	RECOMMENDED FILTER	PART NO.
9/20	0.009	20	180 Mesh	0526209
9/40	0.009	40	180 Mesh	0526409
11/10	0.011	10	180 or 100 Mesh	0526111
11/20	0.011	20	180 or 100 Mesh	0526211
11/40	0.011	40	180 or 100 Mesh	0526411
13/10	0.013	10	100 Mesh	0526113
13/20	0.013	20	100 Mesh	0526213
13/40	0.013	40	100 Mesh	0526413
15/10	0.015	10	100 Mesh	0526115
15/20	0.015	20	100 or 50 Mesh	0526215
15/40	0.015	40	100 or 50 Mesh	0526415
17/20	0.017	20	50 Mesh	0526217
17/40	0.017	40	50 Mesh	0526417

## GM5000 Electrostatic Gun & Powerpack 0521133

Up to 20% higher transfer efficiency than competitive electrostatic sprayers.

- High-voltage ON/OFF at the gun
- Automatic error indication
- Easy to adjust atomization and pattern shape
- Comes complete with gun, hose, round and flat tip
- Add electrostatic capability to any airless sprayer



## For Textured Applications

### Splatter Nozzle 765-360

Add the splatter nozzle to any airless spray gun for smooth texture applications including orange peel and knock down. For best results use with M Series Airless Guns.

Air requirement 4-12 CFM at full open.



# THE INDUSTRY LEADER IN TIP TECHNOLOGY

Airless spray tips are a key component to the successful operation of an airless spray system. They define the spray pattern, control the flow, atomize the coating and ultimately tell the pump how hard it must work. A proper understanding of airless tips is critical to the success of any airless application.



## Tip Characteristics

It is important to remember that the orifice size, in conjunction with the fan-width, determines the spray characteristics of the tip.

## Tip Wear

When beginning a project, choosing the right tip size and fan width will determine both coating consumption and production time. If the tip size is wrong — either by choice or through wear — mil thicknesses will be too heavy and the finish will be unprofessional.

The spray pattern chart demonstrates what happens as a tip wears. As wear occurs, the pattern size decreases and the orifice size increases. You will have to make more passes to cover the same area. There is no standard rate of tip wear due to the variation of the abrasiveness of all coatings.

## Examples for Understanding Airless Tips

### Example A:

The larger the orifice with the same fan width, the greater the volume of paint applied to the area.

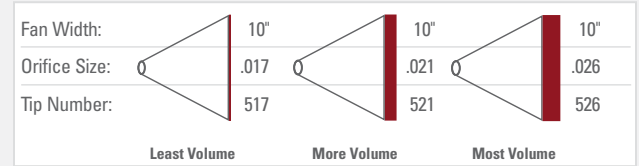

### Example B:

The larger the fan width with the same orifice means the same amount of material is being applied over a greater area. The result is less volume of paint per square inch.

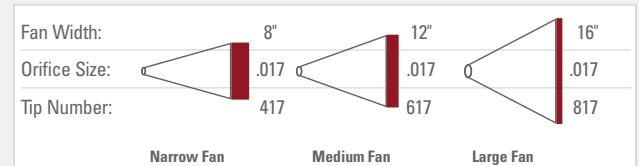

## How a Tip Fan Pattern Typically Wears

SC-6+ WITH 517 TIP			
SPRAY PATTERN WIDTHS			
New 517	Worn to 419	Worn to 321	Worn to 223
FLOW RATES			
.31 gpm (1.17 lpm)	.39 gpm (1.47 lpm)	.47 gpm (1.78 lpm)	.57 gpm (2.15 lpm)
FLOW RATE INCREASE			
0%	26%	52%	84%

TR <sup>1</sup> WITH 517 TIP			
SPRAY PATTERN WIDTHS			
New 517	Worn to 519	Worn to 521	Worn to 523
FLOW RATES			
.31 gpm (1.17 lpm)	.39 gpm (1.47 lpm)	.47 gpm (1.78 lpm)	.57 gpm (2.15 lpm)
FLOW RATE INCREASE			
0%	26%	52%	84%

# PREMIUM TR<sup>1</sup> REVERSIBLE TIP

- The best overall performing tip in the industry
- Fan pattern stays wider longer
- An orifice that outlasts competitive tips delivering consistent film thickness and less wasted paint
- Fits all Titan and most other industry spray gun guards

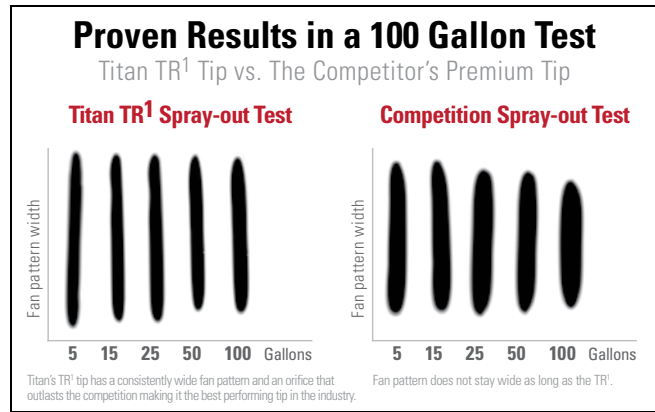

## TR<sup>1</sup> Tips 695-XXX

		ORIFICE SIZE (INCHES)										
		0.009	0.011	0.013	0.015	0.017	0.019	0.021	0.025	0.027		
FAN PATTERN WIDTH	INCHES	MM										
	2-4	51-102										
	4-6	102-152	209	211	213	215	217					
	6-8	152-203		311	313	315	317					
	8-10	203-254		411	413	415	417					
	10-12	254-305			513	515	517	519	521	525		
	12-14	305-356									627	
	Flow (GPM)	---	0.09	0.12	0.18	0.24	0.31	0.39	0.47	0.67	0.78	
	Flow (LPM)	---	0.34	0.45	0.68	0.91	1.17	1.47	1.78	2.53	2.95	

Maximum Working Pressure: 5000 PSI (34.5 MPa)



## TR<sup>1</sup> High Pressure Tips 696-XXX

		ORIFICE SIZE (INCHES)																				
		0.007	0.009	0.011	0.013	0.015	0.017	0.019	0.021	0.023	0.025	0.027	0.029	0.031	0.033	0.035	0.037	0.039	0.043	0.045	0.055	
FAN PATTERN WIDTH	INCHES	MM																				
	2-4	51-102	107	109	111	113	115	117	119													
	4-6	102-152		209	211	213	215	217	219	221	223	225	227									
	6-8	152-203		309	311	313	315	317	319	321	323	325	327	329	331	333	335	337	339			
	8-10	203-254		409	411	413	415	417	419	421	423	425	427	429	431	433	435		439	443	445	455
	10-12	254-305		509	511	513	515	517	519	521	523	525	527	529	531	533	535	537	539	543	545	555
	12-14	305-356		609	611	613	615	617					627									655
	14-16	356-406						717	719	721	723	725	727		731	733	735					
	16-18	406-457						817	819	821						835	837	839	843			
	18-20	457-508										923	925	927		931		937				
	Flow (GPM)	---	0.05	0.09	0.13	0.18	0.24	0.31	0.39	0.47	0.57	0.67	0.78	0.91	1.03	1.17	1.32	1.40	1.64	1.99	2.18	3.26
	Flow (LPM)	---	0.19	0.34	0.45	0.68	0.91	1.17	1.47	1.78	2.15	2.53	2.95	3.44	3.89	4.42	4.99	5.29	6.20	7.52	8.24	12.32

Maximum Working Pressure: 7700 PSI (53.1 MPa)

## TR<sup>1</sup> Line Striping Tips 697-XXX

		ORIFICE SIZE (INCHES)													
		0.013	0.015	0.017	0.019	0.021	0.023	0.025	0.027	0.029	0.031	0.035	0.039	0.043	
FAN PATTERN WIDTH	INCHES	MM													
	2	51	213	215	217	219									
	4	102	413	415	417	419	421	423	425	427	429	431	435	439	443
	6	152		615	617	619	621	623	625	627	629	631	635	639	643
	8-10	203-254					821	823	825	827	829	831	835	839	843
	Flow (GPM)	---	0.18	0.24	0.31	0.39	0.47	0.57	0.67	0.78	0.91	1.03	1.32	1.64	1.99
	Flow (LPM)	---	0.68	0.91	1.17	1.47	1.78	2.15	2.53	2.95	3.44	3.89	4.99	6.20	7.52

Maximum Working Pressure: 5000 PSI (34.5 MPa)





# TR<sup>1</sup> HEA TIP



Perfect for interior and exterior residential and commercial wall spraying.



## The Right Mix For Production 330-XXX

FAN PATTERN WIDTH	INCHES	MM	ORIFICE SIZE (INCHES)					
			0.011	0.013	0.015	0.017	0.019	0.021
4-6	102-152	211	213					
6-8	152-203	311	313					
8-10	203-254	411	413	415	417		421	
10-12	254-305			515	517	519	521	
12-14	305-356			615	617	619	621	
Flow (GPM)	---	0.13	0.18	0.24	0.31	0.39	0.47	
Flow (LPM)	---	0.34	0.45	0.68	0.91	1.17	1.79	

Maximum Working Pressure: 5000 PSI (34.5 MPa)

## HEA | HIGH EFFICIENCY AIRLESS™

### Revolutionary Low Pressure Technology

- Optimized to spray all architectural paints and coatings at 1,000 psi at production speed
- Decreases overspray up to 55% allowing contractors to spray more
- Less pressure equals less stress extending pump life and extending time between repacks
- Two times the life of a standard reversible tip
- Patented design

### HIGHLY EFFICIENT FAN PATTERN

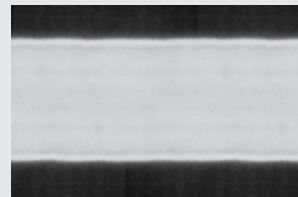

Latex paint through a standard 517 tip at 1,000 PSI



Latex paint through a HEA 517 tip at 1,000 PSI

- Feathered edge provides consistent coverage
- More forgiving pattern that decreases runs and drips
- Less kickback when triggered providing more control and less overspray
- Fits all industry standard guards

### Maximize the Performance of your HEA Tip



HEA Gauge Assembly Kit 0580495

# HIGH QUALITY SC-6+ REVERSIBLE TIP

- ▶ The industry's longest-lasting orifice
- ▶ Up to 22% wider fan pattern
- ▶ Fits all Titan and most industry standard guards



**TITAN TIPS PAINT MORE**  
Titan Tips Vs. the Competition

Long-lasting orifice gives you more usable tip life, spraying a consistent film thickness and wasting less paint.

100 Gallons sprayed with a Titan SC-6+ tip\*      100 Gallons sprayed with the competitor's standard tip\*

\*Assumes consistent application method

## SC-6+ Tips 662-XXX

		ORIFICE WIDTH (INCHES)																				
		0.007	0.009	0.011	0.013	0.015	0.017	0.019	0.021	0.023	0.025	0.027	0.029	0.031	0.033	0.035	0.039	0.043	0.045	0.051	0.055	
FAN PATTERN WIDTH	INCHES	MM	107	109	111	113	115	117														
	2-4	51-102	207	209	211	213	215	217	219	221	223	225	227	229	231	233	235					
	4-6	102-152	307	309	311	313	315	317	319	321	323	325	327	329	331	333	335					
	6-8	152-203	407	409	411	413	415	417	419	421	423	425	427	429	431	433	435	439	443	445	451	455
	8-10	203-254		509	511	513	515	517	519	521	523	525	527	529	531	533	535	539	543	545	551	555
	10-12	254-305		609	611	613	615	617	619	621	623	625	627	629	631	633	635	639	643	645	651	655
	12-14	305-356							719	721					731		735					
	14-16	356-406								821					831							
16-18	406-457																					
	Flow (GPM)	---	0.05	0.09	0.13	0.18	0.24	0.31	0.39	0.47	0.57	0.67	0.78	0.91	1.03	1.17	1.32	1.64	1.99	2.18	2.80	3.26
	Flow (LPM)	---	0.19	0.34	0.45	0.68	0.91	1.17	1.47	1.78	2.15	2.53	2.95	3.44	3.89	4.42	4.99	6.20	7.52	8.24	10.58	12.32

Maximum Working Pressure: 5000 PSI (34.5 MPa)

## SC-6+ Widespray Tips 661-XXX

		ORIFICE SIZE (INCHES)					
		0.019	0.021	0.023	0.025	0.027	
FAN PATTERN WIDTH	INCHES	MM	1219	1221	1223	1225	1227
	24-26	610-660	0.39	0.47	0.57	0.67	0.78
	Flow (GPM)	---	1.47	1.78	2.15	2.53	2.95
	Flow (LPM)	---					

Maximum Working Pressure: 5000 PSI (34.5 MPa)



## SC-6+ Synergy Fine Finishing Tips 671-XXX

		ORIFICE SIZE (INCHES)				
		0.008	0.010	0.012	0.014	
FAN PATTERN WIDTH	INCHES	MM	208	210	212	214
	4-6	102-152	308	310	312	314
	6-8	152-203	408	410	412	414
	8-10	203-254		510	512	
	10-12	254-305			612	
	12-14	305-356				
	Flow (GPM)	---	0.07	0.11	0.16	0.21
	Flow (LPM)	---	0.26	0.42	0.60	0.79

Maximum Working Pressure: 5000 PSI (34.5 MPa)



# A FULL SPECTRUM OF SPRAY TIPS FOR A FULL RANGE OF APPLICATIONS

## Flat Tips 002-XXX

- Precision machined from the highest quality Tungsten Carbide
- Solvent-proof seal holds up against the harshest coatings
- Pressure rated to 5000 PSI (34.5 MPa)



		ORIFICE SIZE (INCHES)											
		INCHES	MM	.007	.009	.011	.013	.015	.017	.018	.019	.021	.023
FAN PATTERN WIDTH	2-4	51-102	107	109	111		115	117		119	121	223	
	4-6	102-152	207	209	211	213	215	217		219	221	225	
	6-8	152-203		309	311	313	315	317	318	319	321	323	
	8-10	203-254	407	409	411	413	415	417	418	419	421	423	
	10-12	254-305	507	509	511	513	515	517	518	519	521	523	
	12-14	305-356	607		611	613	615	617	618	619	621	623	
	14-16	356-406				713	715	717		719	721	723	
	16-18	406-457				811	813	815	817	818	819	821	823
	18-20	457-508				913	915		918			923	
	20-22	508-559							1017			1021	
	22-24	559-610											
	24-26	610-660				1213	1215			1218		1221	1223
	26-28	660-711											
	Flow (GPM)		---	0.05	0.09	0.13	0.18	0.24	0.31	0.35	0.39	0.47	0.57
Flow (LPM)		---	0.19	0.34	0.49	0.68	0.91	1.17	1.32	1.47	1.78	2.15	

		ORIFICE SIZE (INCHES)																					
		INCHES	MM	.025	.026	.027	.029	.031	.033	.035	.036	.039	.041	.042	.043	.047	.049	.052	.055	.058	.062	.072	
FAN PATTERN WIDTH	2-4	51-102						231															
	4-6	102-152	225					231															
	6-8	152-203	325		327			331			336			342				352					
	8-10	203-254	425	426	427	429	431	433	435	436	439	441		443		449	452						472
	10-12	254-305	525		527	529	531		535	536	539			543		549	552			558	562		
	12-14	305-356	625	626	627		631	633	635	636		641			643		652	655					
	14-16	356-406	725		727		731		735														
	16-18	406-457	825		827		831		835	836	839			843	847								862
	18-20	457-508	925	926			931		936														962
	20-22	508-559					1031																
	22-24	559-610									1136				1143								
	24-26	610-660		1226		1229	1231																
	26-28	660-711								1336													
	Flow (GPM)		---	0.67	0.73	0.78	0.91	1.03	1.17	1.32	1.40	1.64	1.81	1.90	1.99	2.38	2.58	2.91	3.26	3.62	4.14	5.58	
Flow (LPM)		---	2.53	2.76	2.95	3.44	3.89	4.42	4.99	5.29	6.20	6.84	7.18	7.52	9.00	9.75	11.00	12.32	13.68	15.65	21.09		

## Adjustable Self-cleaning Tips 341-XXX

- Fully adjustable fan widths from 2" to 24" reduce overspray
- Perfect when changing from spraying walls to cutting in for trim work or around windows
- Self-cleaning feature eliminates costly downtime

ORIFICE RANGE	COATING RANGE	PART NO.
.005-.018	Lacquer and Stain	341-015
.007-.019	Lacquer and Stain	341-020
.007-.026	Lacquer and Enamels	341-024
.011-.026	Lacquer and Enamels	341-028
.017-.035	High Builds	341-041
.021-.054	Very Heavy	341-049



► Metering Orifice

Adjustable Self-cleaning Tip ►

## Metering Orifice 512-XXX

Designed to produce a more complete atomization of the spray pattern. Increases your transfer efficiency by allowing you to spray at lower pressures and assists in atomizing difficult coatings.

When ordering, always use a metering orifice that is at least .004 larger than the spray tip being used. Example: a .019 tip should be used with a .023 Metering Orifice.

ORIFICE - INCHES	MAX. RECOMMENDED TIP SIZE	PART NO.
.011	.007	512-011
.013	.009	512-013
.015	.011	512-015
.018	.013	512-018
.021	.017	512-021
.023	.019	512-023
.026	.021	512-026
.031	.026	512-031
.035	.031	512-035
.039	.035	512-039

# A GUARD FOR EVERY TIP

Titan tip guards are designed to maximize airflow with minimal overspray. With a guard for every tip and the universal fitting which matches most industry standard guns we have you covered.



## No Build Guard (7/8") 0289228

Aerodynamic dimple design allows for better airflow and less paint build up. Seal cavity on safety guard has large "flats" for quick and easy installation of seal.

- ◆ Rotate guard without loosening from gun
- ◆ No tools needed for installation
- ◆ Interchangeable with most industry spray guns
- ◆ Pressure rated at 5000 PSI (34.5 MPa)

## High Pressure Tip Guard (7/8") 661-027

- ◆ Interchangeable with most industry spray guns
- ◆ Pressure rated at 7700 PSI (53 MPa)

## Adjustable and Flat Tip Guard

- ◆ Interchangeable with most industry spray guns
- ◆ Pressure rated at 5000 PSI (34.5 MPa)



DESCRIPTION	PART NO.
7/8" - 14	450-100A
11/16" - 14 (Flat tips only)	0153003



## Seals

DESCRIPTION	PART NO.
Metal Retainer	651-040
Black Seal, Latex	651-042
White Seal, Solvent Resistant	651-020
White Seal, Solvent Resistant (6-pack)	661-021
Seal and Retainer Kit, Solvent Resistant (5-pack)	661-020
Seal and Retainer Kit, Solvent Resistant (12-pack)	651-060
Gasket Kit, 1/8" (12-pack)	711-612A
Gasket Kit, 1/16" (12-pack)	711-606

# THE BEST FILTERS AVAILABLE

Nothing destroys a piston or a gun tip faster than debris in the coating. That's why you need the best paint filters available. Titan gun filters and manifold filters are designed for long life and maximum protection. They are made from stainless steel for strength and service. We offer a wide variety of mesh sizes from 0 to 150.

## Gun and Pump Filters

Unthreaded filter design for quick and easy replacement.

For use with RX-Pro™, RX-80™, G-10, LX-30, LX-40, LX-50, LX-70, S-3 and S-7.

UNTHREADED		
FILTERS	BULK PART NO.	2-PACK PART NO.
Coarse (Green)*	581-059	0089957
Medium (White)	581-060	0089958
Fine (Yellow)	581-062	0089959
Extra Fine (Red)	581-061	0089960

\*Manifold filter for Advantage 400.



For use with LX-80<sup>II</sup> and LX-80 Platinum.

THREADED		
FILTERS	BULK PART NO.	2-PACK PART NO.
Coarse (Green)*	540-030	500-200-03
Medium (White)	540-060	500-200-06
Fine (Yellow)	540-100	500-200-10
Extra Fine (Red)	540-150	500-200-15

\*Manifold filter for 440i and Impact 400.



Pump Manifold Filters

## Pump Manifold Filters

For use on Impact® 410–1140; 640ix–1140ix and Elite 3500.

MESH	PART NO.
Coarse-30 Mesh	730-067-30
Medium-60 Mesh	730-067
Fine-100 Mesh	730-067-10

For use on PowrTwin™ 4900, 5500, 6900, 8900, 10000 and 12000 Plus. PowrBeast™ 4700/7700/9700

MESH	PART NO.
Mastic-0 Mesh	930-004
Coarse-5 Mesh	930-005
Medium-50 Mesh*	930-006
Fine-100 Mesh	930-007

\*Standard with sprayer. Includes ball.



For use on Hydra™, PowrTwin 3500 and 4500.

MESH	PART NO.
Coarse-5 Mesh	920-001
Medium-50 Mesh*	920-004
Fine-100 Mesh	920-005

\*Standard with sprayer, excludes ball. Ball check sold separately (920-103).

For use on all 10" PowrCoat™ models.

MESH	PART NO.
Medium-60 Mesh	0533514

For use on Titan E15, E20, G40 and G55.

MESH	PART NO.
Coarse-30 Mesh	761-042

## Pump Manifold Filter Plugs



MESH	PART NO.
Impact 400, 410	0532357
Impact 440, 540, 640	0552934
Impact 740-1140 and 1200SF	0558668

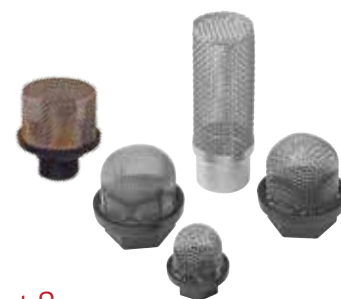

## Inlet Screens

SMALL		
MESH	BULK PART NO.	PACKAGED PART NO.
30 mesh (Fine)	700-900	700-900A
10 mesh (Coarse)	700-805	700-805A
30 mesh (Male)	----	0552947*

\*For PowrLiner 550 and 850 only

LARGE		
MESH	BULK PART NO.	PACKAGED PART NO.
30 mesh (Fine)	710-191	710-191A
10 mesh (Coarse)	710-046	710-046A

HYDRAULIC AND PNEUMATIC	
DESCRIPTION	PART NO.
PowrTwin 4900, 6900, 8900, 12000 Plus and XLT	0509762A
All GHD	710-046A
Hydra Pro IV	0509762A
PowrCoat 10" (30 Mesh)	0533968

## In-Line Filter 550-223

Designed for added filtration or when using a gun without a filter.



In-line Gun Filter



# WHEN YOUR ARMS JUST AREN'T LONG ENOUGH

- ◆ Maximize the speed and efficiency of your operation
- ◆ Minimize danger – eliminate reaching from ladders
- ◆ Get the job done safely and quickly the first time
- ◆ Paint easily from a safe distance, keeping yourself and clothing clean



## SprayGuide™

May your lines be straighter and your profits greater! This unique free-wheeling disc glides smoothly over virtually every surface.

Cut-in around windows, doors, trim and more without time-consuming prep work.

- ◆ Eliminates time-consuming masking or cutting in with brush
- ◆ Attaches to a gun extension or an extension pole (sold separately) decreasing ladder work
- ◆ Best if used with a 411 tip. (Not included)
- ◆ Pressure rated at 3600 PSI (24.8 MPa)

DESCRIPTION	PART NO.
SprayGuide Complete Kit	0538900
SprayGuide Replacement Arm and Disk Only	0538902



## Aluminum Gun Extensions

Our aluminum gun extensions are lightweight and easy to handle and can be used with all 7/8" thread airless spray guns.

- ◆ Pressure rated at 3600 PSI (24.8 MPa)

7/8" x 14 Thread is Standard

DESCRIPTION	PART NO.
6" (15 cm)	651-070
12" (30 cm)	651-071
18" (45 cm)	651-072
24" (60 cm)	651-073

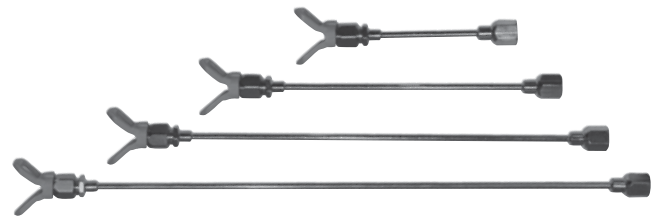

## High Pressure, Alloy Steel Gun Extensions

When you need something a little more heavy duty. Can be used with all 7/8" thread airless spray guns.

- ◆ Pressure rated at 7700 PSI (53.1 MPa).

7/8" x 14 Thread is Standard

DESCRIPTION	PART NO.
6" (15 cm)	611-280
12" (30 cm)	611-281
18" (45 cm)	611-282
24" (60 cm)	611-283



**Swivel Head** 0538029

Titan's new easy turn swivel rotates 260 degrees for greater versatility and accessibility.

- Pressure rated at 3600 PSI (24.8 MPa)

DESCRIPTION	PART NO.
7/8" x 14 Thread Swivel Head - Female	0538029
7/8" x 14 Thread Swivel Head - Male	711-600



**Extension Pole**

These lightweight aluminum extensions are constructed with inner core ribs which reinforce the poles and greatly increase their rigidity. The inner core rib construction allows different length poles to be easily coupled together up to 12', while maintaining the proper rigidity to suit most job conditions.

- Reach high out-of-the-way places when spray or pressure rolling
- Adapts to most airless guns
- Includes Extension Pole Coupling (0509908)
- Pressure rated at 3600 PSI (24.8 MPa)

DESCRIPTION	PART NO.
1.5' (0.46 m) Pole	310-381-1
3' (0.9 m) Pole	310-383-1
6' (1.8 m) Pole	310-386-1
3' Extension Pole with Swivel Head, 7/8" Nut	310-390
6' Extension Pole with Swivel Head, 7/8" Nut	0279976L

**LX-75 In-Line Gun** 550-475

- All metal construction
- A natural extension to any pole
- In-handle filter
- Swivel reduces hose kinks and ensures effortless control
- Pressure rated at 3600 PSI (24.8 MPa)

Repair Kit (550-521)



**6' Outrigger** 757-920

Convert existing gun to 6' (2 m) pole gun and back in seconds. Outrigger allows you to increase production and profits. No additional hoses or fittings required.

- Constructed of lightweight and rigid aluminum to reduce arm fatigue
- Large gun installation holder and knob
- Adapts to all Titan airless spray guns and most manufacturers' airless spray guns



**LX-75 Pole Gun** 550-495

Reach those high, out-of-the-way places that normally require the use of a ladder or scaffolding.

- All metal construction
- Full-length needle ensures positive shut-off at tip
- Gun swivel
- In-handle filter
- Ergonomic design
- Pressure rated at 3600 PSI (24.8 MPa)

Repair Kit (550-487)

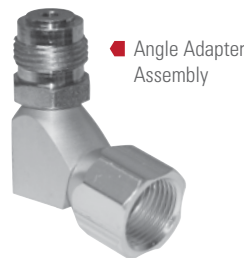

**Angle Adapter Assembly** 0509907

Adapt any extension pole to any standard airless gun. Because of its right-angle design, the angle adapter allows the pole to extend from the gun at the same angle as the handle. The result is greater efficiency and comfort.

- Pressure rated at 3600 PSI (24.8MPa)

**Extension Pole Coupling** 0509908

Allows you to connect different length extruded poles together to create different lengths for any application. (Do not exceed 12')

# THE RIGHT EQUIPMENT FOR THE JOB



## High Quality Airless Fluid Hoses and Whip Hoses

I.D.	LENGTH		MAX. WORKING PRESSURE - PSI (MPa)					END CONNECTION
			3300 (22.8)	3600 (24.8)	4500 (31.0)	6500 (44.8)	7500 (51.7)	
	FEET	METERS	PART NO.	PART NO.	PART NO.	PART NO.	PART NO.	
1/8"	3	0.9	---	---	290685	---	---	1/4" NPSM (F/M)
	3	0.9	291004	---	---	---	---	1/4" NPSM (F/M)
3/16"	5	1.5	316-506	---	---	---	---	1/4" NPSM (F/M)
	9	2.7	550-222	---	---	---	---	1/4" NPSM (F/M)
	25	7.6	291007	---	---	---	---	1/4" NPSM (FBE)
	50	15.2	291008	---	---	---	---	1/4" NPSM (FBE)
1/4"	3	0.9	---	---	2389428	2389440	2389450	1/4" NPSM (FBE)
	6	1.8	316-533*	---	2389430	2389442	2389452	1/4" NPSM (FBE)
	6	1.8	550-227	---	---	---	---	1/4" NPSM (FBE)
	12	3.7	2408659	---	---	---	---	1/4" NPSM (FBE)
	25	7.6	316-513	---	---	---	---	1/4" NPSM (FBE)
	50	15.2	316-505	286498	2389429	2389441	2389451	1/4" NPSM (FBE)
	100	30.5	---	---	2389427	2389439	2389449	1/4" NPSM (FBE)
3/8"	6	1.8	---	---	2389436	2389446	2389456	3/8" NPSM (FBE)
	25	7.6	508342	---	---	---	---	3/8" NPSM (FBE)
	50	15.2	291006	286499	2389434	2389445	2389455	3/8" NPSM (FBE)
	100	30.5	---	---	2389432	2389444	2389453	3/8" NPSM (FBE)
1/2"	25	7.6	225-112*	---	---	---	---	1/2" NPSM (FBE)
	50	15.2	250-112*	---	2389425	2389438	2389448	1/2" NPSM (FBE)
	100	30.5	---	---	2389424	2389437	2389447	1/2" NPSM (FBE)
3/4"	50	15.2	---	---	---	2389443	---	3/4" NPSM (FBE)

\*Textile Braid. Spring guards at both ends.

FBE Female Both Ends, NPT National Pipe Tapered Thread, NPSM National Pipe Straight Mechanical Thread, MBE Male Both Ends, F/M 1 Female / 1 Male Connection

## Moisture Resistant Hose

DESCRIPTION	PART NO.
3/8" x 7500 PSI x 50'	375750050ML
1/2" x 7500 PSI x 50'	500750050ML
3/4" x 1000 PSI Transfer hose	750100012R



## Hose Shield 0521424

Protect your airless hose from paint and abrasion damage with a durable four-mil poly hose cover. Comes in 1100' lengths with perforations every 5' to fit any length of hose. Works with 1/4" and 3/8" hoses.



Hose sold separately.



## Reel-EZ Hose Reels

Eliminate hose hassles while increasing your production. Both models mount to most major manufacturers' paint sprayers with similar designs.

- ▶ The 16" Cart-Mount holds up to 100' (30.5 m) of 1/4" airless hose
- ▶ The 10" Skid-Mount holds up to 50' (15.2 m) of 1/4" airless hose
- ▶ Pressure rated at 3600 PSI (25 MPa)

Fits handles/carts 3/4" to 1-1/2" in diameter.

DESCRIPTION	PART NO.
16" Cart-Mount	769-100
10" Skid-Mount	769-200



## High Pressure Swivels

- ▶ Decreases resistance while spraying reducing overall fatigue
- ▶ Reduces hose kinking
- ▶ Pressure rated at 5000 PSI (34.5 MPa)

DESCRIPTION	PART NO.
<b>Gun-to-Hose / Hose-to-Pump</b> 1/4" (0.63 cm) NPS (F) x 1/4" (0.63 cm) NPS (M)	0509985
<b>Hose-to-Hose</b> 1/4" (0.63 cm) NPS (M) x 1/4" (0.63 cm) NPS (M)	0502135



## Air Spray Hoses

DESCRIPTION	PART NO.
30' x 3/8" Air (Red)	0295689
30' x 3/8" Fluid (Black)	0277348

## Air-Assisted Airless Spray Hoses

DESCRIPTION	PART NO.
3/16" x 25' Bonded Fluid Hose	9984595
1/4" x 50' Bonded Fluid Hose	0524333
5' Fluid Whip Hose	0550861

## High Pressure Fluid Gauge Kit 0508239

Includes: 5000 PSI (34.5 MPa) high pressure fluid gauge attached to a T-Fitting with one 1/4" (M)(.63cm) fitting & one 1/4" (F)(.63cm) fitting.

Fluid Gauge Only (0508626)



## HEA Pressure Gauge 0580495

Maximize the performance of your TR<sup>1</sup> HEA Tips.



# PRODUCTIVE BACKROLLING



## INTRODUCING THE SPRAYROLLER®

DO TWO JOBS AT ONCE

- Designed to spray and back roll in one motion
  - One person doing the work of two employees
- Reduces overspray decreasing Prep work
- Professional finish from a new/novice applicator
- Provides consistent mil thickness on textured surfaces
- Gives a roller finish; easier to touch-up
- Attaches to the Titan SprayGuide swivel
- Uses any standard roller cover
- Designed to be used with all airless sprayers and extension poles

- Quick tool-free changeover for the complete wall system



SprayRoller Head with TR<sup>1</sup> Tip

## SPRAYGUIDE™ EXCLUSIVE CUT-IN TOOL

- No more taping, no more ladders
- Perfect for windows, doors and roof lines



DESCRIPTION	PART NO.
SprayRoller (no tip)	2403780
SprayRoller Combo Kit*	2403959
SprayRoller Combo Kit* with 3' Pole	2404013

**\*Combo Kit includes:**

9" SprayRoller, SprayGuide, TR<sup>1</sup> 415 Reversible Tip & Swivel Head Assembly





## INNER-FEED ROLLER®

ROLL NON-STOP UNTIL THE JOB IS FINISHED

- Up to four times faster than standard rolling
- Never take the roller off the wall to go back to the tray; when the roller starts to get dry, simply pull the trigger to wet roller cover
- Never have to worry about dry edges
- More consistent mil thickness
- Designed to be used with all airless sprayers and any brand of extension pole

DESCRIPTION	PART NO.
Inner-feed Roller Head	2404445
Seal and O-Ring	514112
Roller Core w/Cap	514118



Inner-feed  
Roller Head

### INNER-FEED ROLLER REPLACEMENT COVERS

- Perforated high-density knit polyester roller cover
- Distributes paint evenly for a smooth finish

DESCRIPTION	NAP	PART NO.
9" (23 cm)	3/4" (1.90 cm)	0155208B
9" (23 cm)	3/8" (0.95 cm)	0155206K

# A FITTING FOR EVERY JOB

Spraying is more than just hooking up a hose. Sometimes the situation calls for extending hose length or altering the angle of the hose connected to the sprayer. That's when you need Titan manifolds and fittings. Our fittings are manufactured from quality carbon steel and plated for maximum corrosion resistance.

## Couplings

HOSE TO HOSE		
DESCRIPTION	BULK PART NO.	PACKAGED PART NO.
1/4" NPT(M) x 1/4" NPT(M)	5045	550063
1/4" NPT(M) x 3/8" NPT(M)	812-003	550064
3/8" NPT(M) x 3/8" NPT(M)	490-014	550066
1/2" NPT(M) x 1/2" NPS(M)	449-621	-----

Maximum Working Pressure: 5000 PSI (34.5 MPa)



HIGH PRESSURE HOSE TO HOSE	
DESCRIPTION	PART NO.
1/4" x 1/4" NPSM	367560
1/4" x 3/8" NPSM	367561
3/8" NPTF (M) x 3/8" NPTF(M)	9885643
3/8" NPTF (M) x 1/4" NPTF(M)	9885646
1/2" NPTF (M) x 1/4" NPTF(M)	9885644
1/2" NPTF (M) x 3/8" NPTF(M)	9885647
1/2" NPTF (M) x 1/2" NPTF(M)	9885648
3/4" NPSM x 3/8" NPSM	9985783
3/4" x 1/2" NPSM	9985782
3/4" x 3/4" NPSM	9985781
3/4" x 3/8" NPSM	9985783

Maximum Working Pressure: 7500 PSI (51.7 MPa)



MANIFOLD TO MANIFOLD	
DESCRIPTION	PART NO.
1/4" NPT(M) x 1/4" NPT(M)	490-002
1/4" NPT(M) x 3/8" NPT(M)	490-006
3/8" NPT(M) x 3/8" NPT(M)	814-004
3/8" NPT(M) x 1/2" NPT(M)	814-005
1/2" NPT(M) x 1/2" NPT(M)	814-006
1/2" NPT(M) x 3/4" NPT(M)	101-201
3/4" NPT(M) x 3/4" NPT(M)	814-007

Maximum Working Pressure: 5000 PSI (34.5 MPa)



MANIFOLD TO HOSE	
DESCRIPTION	PART NO.
1/8" NPT(M) x 1/4" NPS(M)	490-001
1/4" NPT(M) x 1/4" NPS(M)	227-006
1/4" NPT(M) x 3/8" NPS(M)	804-555
1/4" NPT(M) x 1/2" NPS(M)	814-003
3/8" NPT(M) x 1/4" NPS(M)	812-003
3/8" NPT(M) x 3/8" NPS(M)	808-555
3/8" NPT(M) x 1/2" NPS(M)	815-005
1/2" NPT(M) x 1/2" NPS(M)	228-002
3/4" NPT(M) x 1/2" NPS(M)	814-555

Maximum Working Pressure: 5000 PSI (34.5 MPa)



## 90° Street Elbows

DESCRIPTION	PART NO.
3/8" NPT(F) x 3/8" NPT(M)	818-002
1/2" NPT(F) x 1/2" NPT(M)	818-003
3/4" NPT(F) x 3/4" NPT(M)	818-010

Maximum Working Pressure: 5000 PSI (34.5 MPa)



## Reducer Bushings

DESCRIPTION	PART NO.
3/8" NPT(M) x 1/4" NPT(F)	817-001
1/2" NPT(M) x 1/4" NPT(F)	929-061
1/2" NPT(M) x 3/8" NPT(F)	541-009
3/4" NPT(M) x 1/4" NPT(F)	929-062
1" NPT(M) x 3/4" NPT(F)	929-076
1-1/4" NPT(M) x 1" NPT(F)	929-077

Maximum Working Pressure: 5000 PSI (34.5 MPa)



## Pipe Tees

DESCRIPTION	PART NO.
1/4" NPT(F)	970-023
3/8" NPT(F)	817-002
1/2" NPT(F)	817-003
3/4" NPT(F)	817-004

Maximum Working Pressure: 5000 PSI (34.5 MPa)

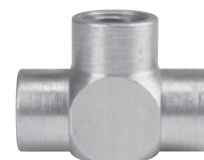

## Swivel Unions

DESCRIPTION	PART NO.
1/4" NPS(F) x 1/4" NPT(M)	490-005
3/8" NPS(F) x 1/4" NPT(M)	490-042
1/4" NPS(F) x 3/8" NPT(M)	490-032
3/8" NPS(F) x 3/8" NPT(M)	490-043
1/2" NPS(F) x 1/2" NPT(M)	200-555
3/4" NPS(F) x 3/4" NPT(M)	138-037
1" NPS(F) x 1" NPT(M)	200-556

Maximum Working Pressure: 5000 PSI (34.5 MPa)



## Pipe Plugs

DESCRIPTION	PART NO.
1/4" NPT(M)	227-027
3/8" NPT(M)	227-033
1/2" NPT(M)	210-023
3/4" NPT(M)	210-038

Maximum Working Pressure: 5000 PSI (34.5 MPa)



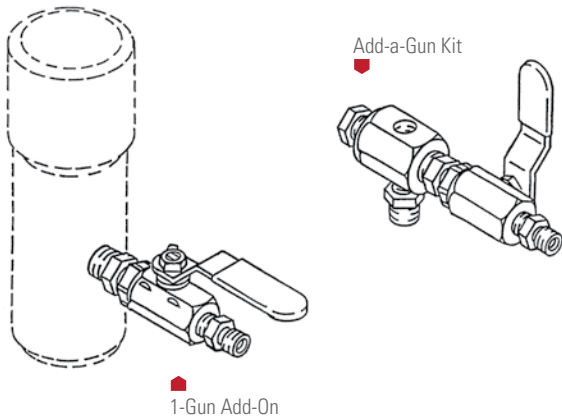

### Gun Add-On Kits:

Can be used on pumps with an open 3/8" NPT port on the manifold.

INCLUDES	1-GUN ADD-ON		ADD-A-GUN	
	975-111 1/4" Hose	975-311 3/8" Hose	975-200 1/4" Hose	975-300 3/8" Hose
	PART NO.	PART NO.	PART NO.	PART NO.
Nipple, Hex	814-002	814-004	814-002	814-004
Ball Valve	940-553	941-555	940-553	941-555
Nipple, Hex	227-006	808-555	227-006	808-555
Plug, Pipe			227-033	227-033
Block, Manifold			970-100	970-100
Nipple, Hex			814-004	814-004

Maximum Working Pressure: 3600 PSI (24.8 MPa)

### Multiple Gun Add-on Assemblies (1/4")

Hose connection 1/4" MPSP (M).

INCLUDES	975-212	975-213
	2-Guns	3-Guns
	QTY.	QTY.
1-Gun Add-On (975-111)	1	1
Add-A-Gun Kit (975-200)	1	2

Maximum Working Pressure: 3600 PSI (24.8 MPa)

### Multiple Gun Add-on Assemblies (3/8")

Hose connection 3/8" NPSM (M).

INCLUDES	975-312	975-313	975-314
	2-Guns	3-Guns	4-Guns
	QTY.	QTY.	QTY.
1-Gun Add-On (975-311)	1	1	1
Add-A-Gun Kit (975-300)	1	2	3

Maximum Working Pressure: 3600 PSI (24.8 MPa)

### High Pressure Ball Valve

FITTING SIZE	PSI	PART NO.
1/4"	6000 (41.4 MPa)	0533358
1/4"	7500 (51.7 MPa)	0533348
3/8"	6000 (41.4 MPa)	0533359
3/8"	7500 (51.7 MPa)	0533347

## FULL FLUID SECTION ASSEMBLIES KEEP YOU ON THE JOB.

### Impact & MultiFinish

DESCRIPTION	PART NO.
Impact® 400 Skid	0532921A
Impact 400 High Rider	0532922A
Impact 410 Skid	0532467A
Impact 410 High Rider	0532468A
Impact 440, 540, 640 (Skid/Low Rider)	805-207A
Impact 440, 540, 640 (High Rider)	805-233A
Impact 740, 840 (All Models)	805-236A
Impact 1040	0552603A
Impact 1140 (High Rider)	805-246A
Impact 1040T	0532437A
Impact 1640	0558358A
Multifinish™ 440	805-207A

### Elite Series

DESCRIPTION	PART NO.
Elite™ 3000, 3500	0537903

### PowrBeast Series

DESCRIPTION	PART NO.
PowrBeast 4700	0537255
PowrBeast 4700T	0537268
PowrBeast 7700, 9700	0537256

### PowrTwin & Hydra Series

DESCRIPTION	PART NO.
PowrTwin™ 4900 Plus (All Models)	107-005
PowrTwin 6900 Plus (All Models)	236-005
PowrTwin 6900 Plus DI (All Models)	451-210
PowrTwin 8900 Plus, 12000 Plus (All Models)	236-015
PowrTwin 12000 Plus DI (All Models)	236-024
Hydra™ Pro IV	185-551A

### PowrLiner Series

DESCRIPTION	PART NO.
PowrLiner™ 2850	0290513A
PowrLiner 4950/4955 (All Models)	107-005
PowrLiner 6950/6955 (All Models)	236-005
PowrLiner 8950/8955 (All Models)	236-015

### AirCoat & PowrCoat Series

DESCRIPTION	PART NO.
AirCoat™ 423	0533243
AirCoat 620	0533244
PowrCoat™ 730, 940	185-551A
PowrCoat 745, 960	155-559A
PowrCoat 975	0533908
PowrCoat 1045	0533262
PowrCoat 1064	0533263
PowrCoat 1072	0533264

# HARD WORKING LINE STRIPER ACCESSORIES

## WindGuard™ Spray Shield 0290623

Spray shield protects spray pattern from wind, minimizing overspray. Works well when applying diluted athletic field marking paints. Adjustable for easy “on the fly” line width changes – 4”, 6” or 8” and is easily removed from sprayer.

- ▀ Attaches to any Titan PowrLiner and most competitive models
- ▀ Spring-loaded shields promote forgiveness on uneven surfaces
- ▀ Lightweight – only 5.5 lbs.



WindGuard™ Spray Shield



Stencil Kit

## Stencil Kits

Molded of 1/8" (.15 cm) polyethylene, these stencils are very durable and lay flat on surfaces for clean and accurate marking.

STENCIL KIT 1	
INCLUDES	PART NO.
39" (99 cm) Handicap	0290932

STENCIL KIT 2	
INCLUDES	PART NO.
39" (99 cm) Handicap	0290933
12" (30 cm) No Parking	
12" (30 cm) Numbers 0–9	

STENCIL KIT 3	
INCLUDES	PART NO.
42" (105 cm) Straight and Curved Arrows	0290934
39" (99 cm) Handicap	
12" (30 cm) Numbers 0–9	
4", 12" (10, 30 cm) No Parking	
4", 12" (10, 30 cm) Fire Lane	
4" (10 cm) Reserved	
4" (10 cm) Visitors	



## TR² Line Striping Tips

From striping to stenciling – with the twist of the tip.

STRIPING TIP SIZE	STENCIL TIP SIZE	FLAG	FILTER COLOR	PART NO.
417	517	Yellow	White	694-1708517
419	519	Yellow	White	694-1908519
421	621	Yellow	White	694-2108621
423	623	Yellow	White	694-2308623

## LineSite™ Laser Pointer 0290175A

Great for starts/stops, curb striping, executing perfectly straight lines and training new employees. High-intensity green laser is easy to see in daylight.



HandiBead™ Bead Dispenser

## HandiBead™ Bead Dispenser 0290953A

Apply glass beads with consistency and accuracy. Eliminates hand tossing glass beads on stop bar or crosswalk applications.

- ▀ Adjustable diffuser can disperse material up to 15" wide



## Glass Bead Dispensing Systems

Includes hopper, hose and dispenser.

DESCRIPTION	PART NO.
1-Gun Kit (4-6")	424-826
2-Gun Kit (4-6")	424-836
1-Gun Kit (12")	424-840
2-Gun Kit (12")	424-841
PowrLiner 3500 Bracket Kit	0290181
<b>Add a Second Dispenser to your One-Gun Kit</b> Second Dispenser with Hose (4-6")	424-816

Compatible with: 4950, 4955, 6950, 6955, 8950, 8955, 4900XLT, 6900XLT and 8900XLT. LazyLiner™ and PowrLiner™ sold separately.



SureTrak™ Floating Gun Kit



LazyLiner™ Tray

## SureTrak™ Floating Gun Kit 759-120

Keeps the gun at the proper height from the surface for perfect lines over rough terrain.

- Works great on pavement, grass and turf
- Attaches to PowrLiner™ 3500, 4950, 4955, 6950, 6955, 8950 and 8955

## LazyLiner Tray

Use this attachable tray system as an option for carrying around additional items.

- For use on the LazyLiner Pro and Elite

DESCRIPTION	PART NO.
LazyLiner Pro Tray (Must add bumper 0290646Z)	0290646Z
LazyLiner Elite Tray	0290645Z
LazyLiner Elite Tray*	2413480

\*For use with LazyLiners that are equipped with Honda Engine

## Second Gun Kit

Comes complete with mounting bracket, airless gun, ¼" x 6' hose and line striping tip. Mounts to 4950, 6950 and 8950 PowrLiner.

DESCRIPTION	PART NO.
S-3 Gun Kit	759-138
PowrLiner 2850 Gun Kit	0290310

## SmartArm™ Assembly 0290382

Built to make line adjustments and transportation quick and easy.

- Pivots down for spraying and up for transportation/storage
- Locks at any angle for curb striping
- Adjust gun height (fan pattern) up/down with the turn of a lever
- Automatically centers spray arm for easy set-up
- Graduated to return to your preferred spray position

## Striper Add-On Accessories

RECOMMENDED GUNS	
DESCRIPTION	PART NO.
LX-40 Gun	550-540
RX-80 Gun	0538015
S-3 Gun	0550060

UPGRADES	
DESCRIPTION	PART NO.
PowrLiner™ 850 Caster Release Kit	0293970
12-Gallon Hopper	759-130
Polyethylene 5-Gallon Pail Cover	759-147
Turf Kit for PowrLiners 4955-8955	759-155

## Hitches and Bumpers

DESCRIPTION	PRO	ELITE
	PART NO.	PART NO.
PowrLiner 2850	0290043Z	0290043Z
PowrLiner 3500 Hitch Kit and Bracket	0537935	0537935
PowrLiner 3500 Hitch Bracket	0290182	0290182
PowrLiner 4950, 4900xlt, 6900xlt, 8900xlt	0290180	0290180
PowrLiner 6950, 8950	0290180	0290180
PowrLiner 4955, 6955, 8955	0290180	0290180
Graco® 3900 and Up	0290050Z	0290050Z
Bumper / Engine Protection Bar	0290646Z	Included

The drivers are not shipped with a hitch; use chart to identify which hitch to order.



# TOOLS FOR THE PERFECT FINISH



Maxum Elite Gun



Maxum II Gun



Maxum Elite Gun with Gravity Cup and Stand

## Maxum Elite Gun

For contractors and finishing professionals who expect flawless results with the versatility to use gravity- or siphon-fed cup gun.

- Removable and reversible fluid chamber design enables use with standard pressurized cup and pressurized gravity cup
- Stainless steel fluid passages
- Fluid needle stays with packing and head assembly for color and tip size changes—allows for easier storage and clean up
- Integrated check valve in gun head
- Patented grip design for stay-cool operation
- Multi-position pick-up tube for spraying at various angles
- Comes standard with a #3 Proset (Needle set)

DESCRIPTION	PART NO.
Maxum Elite Gun with 1 Qt. Cup	0524027
Maxum Elite Gun with Gravity Cup	0524052

### MAXUM ELITE ACCESSORIES

DESCRIPTION	PART NO.
Pressure-Fed 1 Qt. Cup	0524027
Front End Accessory with 1 Qt. Cup Assembly and #3 Proset	0524073
Front End Accessory with 1 Qt. Cup Assembly and #4 Proset	0524074
Gravity Cup Accessory with Stand	0524045

## Maxum II Gun

For maximum control and pinpoint-accurate coating delivery, the Maxum II is an excellent choice for contractors and finishing professionals who need a precise fine finishing tool.

- Ability to convert from non-bleeder to bleeder gun
- Comes standard with a #3 Proset (Needle set) and 1 Qt. cup

DESCRIPTION	PART NO.
Maxum II Gun with Pressure-Fed 1 Qt. Cup	0524041

## Projector Sets

DESCRIPTION	MAXUM II PART NO.	MAXUM ELITE PART NO.
#2 Proset (Fine Finish)	0276254	0524293
#3 Proset (All-Purpose)	0276227	0524294
#4 Proset (High Output)	0276228	0524295
#5 Proset (High Output)	0276229	0524296
#6 Proset (High Output)	0276245	0524297
#7 Proset (Highest Output)	0524211	0524298

Maxum II   
Standard Kit



## Maintenance and Repair Kits

MAINTENANCE KITS		
DESCRIPTION	MAXUM II PART NO.	MAXUM ELITE PART NO.
Deluxe Kit	0279941	0524189
Standard Kit	0279942	0524188

Gun Repair Kit   
for Maxum II Gun



GUN REPAIR KITS / PARTS	
DESCRIPTION	PART NO.
Replacement Check Valve Assemblies (three-pack)	0297051
Check Valve Seals (10-Pack)	0276257
Gun Repair Kit for Maxum II Gun	0277943
Gun Repair Kit for Maxum Elite Gun	0524187
Spring Plate Assembly	0275250
Gun Repair Kit for 3100 Gun (Siphon and Pressure-Fed)	0550985
Gun Repair Kit for 3100 Gun (Gravity Fed)	0552916



REPLACEMENT TURBINE FILTERS	
DESCRIPTION	PART NO.
Air Filter Kit (Pleated) Capspray™ 95, 105 and 115 Atomizing Air	0524523A
Air Filter Kit (Foam-Black) Capspray 75 Motor Cooling	0529390
Air Filter Kit (Foam-Green) Capspray 75 Atomizing Air	0529390
Pre-Filter Kit (Qty. 2) Capspray 55, 75, 95, 105 and 115	0524526A

## Accessories

CUPS AND ACCESSORIES	
DESCRIPTION	PART NO.
1-Qt. Cup Assembly with Swivel Tube	0277183
1-Qt. Replacement Cup	0275573
2-Qt. Remote Cup System (Complete)	0524203
Air-Tight Lid for Paint Cups (Keeps paint fresh for long periods)	0508124
Cup Assembly without Swivel Tube	0275247
600 ml HVLP Top Feed	0524211
Gravity Cup Assembly with Stand	0524045
White, 1 Qt. Cup Gaskets, Hot Solvents (6-pack)	0297052
White, 2 Qt. Cup Gaskets, Hot Solvents	0524337

White, 1 Qt.   
Cup Gaskets





## Air Hoses and Fittings

DESCRIPTION	PART NO.
20' x 3/4" Flex Air Hose	0275276
25' x 3/4" Flex Air Hose	0275277
30' x 3/4" Flex Air Hose	0277337
30' Air Hose	0295689
5' x 3/4" Air Whip Hose	0524405A
30' x 3/8" Material Hose	0277348
Quick Disconnect (F) Turbine	0275625



## HVLP Power Cart

A compact, lightweight solution to major application projects.

HVLP POWER CART & ACCESSORIES	
DESCRIPTION	PART NO.
HVLP Power Cart	0524000
Pressure Pot Liner	0275702
Pressure Pot Liner (12-Pack)	0295272
Solvent Resistant Gasket	0508943

## 2 Qt. Remote Cup 0524203

Transform your turbine system into a high-capacity sprayer without adding the cost and weight of a bulky air compressor.

For use with Capspray 75-115 sprayers.  
5' Air whip hose sold separately.



Gun sold separately.



## 3M® PPS™ Paint Preparation System

3M PPS Paint Preparation System is a unique, closed paint system that eliminates the need for separate mixing cups and filters. Instead, paint is mixed in a liner bag which marries to a direct filter and is then mounted on the spray gun with a dedicated adapter.

- As freshly-filtered paint is dispensed, the liner bag collapses, allowing the spray gun to function at any angle.
- Liner bag and filter are disposable, leaving only the spray gun and adapter to be cleaned.
- 3M PPS Paint Preparation System is a cleaner, faster system, safe from outside contamination and offers considerable time and solvent savings on gun and parts cleaning.

DESCRIPTION	PART NO.
Series 2.0 3M PPS Starter kit (Cup, Gun Adapter and 10 lid and liners.)	CA91-589
Series 2.0 Pressure Cup	CA91-560
Series 2.0 Lids/Liners 10-pack	CA91-562
Series 2.0 PPS Adapter for Pressure Spray Gun	CA91-575

# KEEP YOUR EQUIPMENT CLEAN AND WORKING FOR YOU

No matter what the sprayer – hydraulic, gear-driven, gas-powered or electric – if you want a long service life you will need to care for it with the same attention you care for your own car or truck. That means changing the oil, lubricating the piston, cleaning the unit, the gun and the tip. Titan has all the products you need to keep your accessories and equipment clean and functioning in top condition.

## PumpRunner 0286008

PumpRunner prevents the inlet valve from drying out, ensures clean transport and reduces clean up time. Works on most high rider model sprayers.

Sprayer sold separately.



## LS-10 Liquid Shield Plus™

Cleans and protects your spray system against rust and corrosion, extending the life of your pump.

- Includes anti-freeze protection to -32C (-25F)

DESCRIPTION	PART NO.
4 oz. Bottle	314-483
1 Qt. Bottle	314-482
1 Gallon Bottle	0521418

## Pump Shield™ 0297055

Cover your sprayer to prevent paint overspray from sticking to it. Keeps your sprayer looking like new.



## Tip Clean™ 314-207

Hour-glass design allows easy cleaning of all airless tips and safe storage. Cleaning fluid removes contamination and paint residue, ensuring best spraying results. **7 oz. (200 ml) Bottle**

## Piston Lube™

Specially formulated to prevent materials from adhering to the piston rod.



- Proven to effectively reduce cylinder abrasion, piston wear
- Keep piston and packings properly lubricated for longer life

DESCRIPTION	PART NO.
4 oz. Bottle	314-481
8 oz. Bottle	314-480
1 Qt. Bottle	700-926

Suitable for use with most airless piston pumps

## Paint Mate™

Water-based coating additive that significantly improves atomization with HVLP sprayers without compromising the integrity of the coating.



DESCRIPTION	PART NO.
1 Qt. Bottle	0508071

## Air Care™ 311-101

Pneumatic equipment lubricant storage protector. Contains premium additives to extend life of equipment. **1 Qt. Bottle**



## Coolflo™

Hydraulic Fluid for PowrTwin™, Hydra™ and sealed hydraulic sprayers.

DESCRIPTION	PART NO.
1 Qt. Bottle	430-362

## Lubriplate™/GR-132

Specially designed for gear boxes.



DESCRIPTION	PART NO.
14 oz. Can	314-171

## Part Renu™

Safely remove paint from spray guns and sprayer accessories. This non-flammable, water-based cleaner is environmentally safe, odor free and will not burn skin. Easily washes off with water.



- Starter Kit includes easy-to-use strainer

DESCRIPTION	PART NO.
1 Gallon Part Renu™	0521423
5 Gallon Starter Kit	0521010

# WEAR GUARD

CONVENIENCE PROGRAM



## PLATINUM PROGRAM

**GET A SPARE FLUID SECTION**  
at a discounted rate  
when you purchase a qualifying sprayer

**LEVEL 1** Impact® 410 **\$172<sup>00</sup>**  
CAD \$251.00

**LEVEL 4** PowrTwin® 4900, 6900, 8900,  
12000 Plus, 6900 Plus DI, 12000 Plus DI;  
PowrBeast™ 4700, 7700, 9700;  
PowrLiner™ 4955, 6955, 8955 **\$345<sup>00</sup>**  
CAD \$503.00

**LEVEL 2** Impact® 440, 540, 640;  
MultiFinish® 440;  
PowrLiner® 2850 **\$250<sup>00</sup>**  
CAD \$364.00

**LEVEL 5** Impact 1040T, 1640;  
PowrCoat® 730, 745, 940, 960,  
975, 1045, 1064, 1072 **\$645<sup>00</sup>**  
CAD \$940.00

\*IMPACT® 440, 540 640 FLUID SECTIONS  
**INCLUDE \$375 IN ADDED FEATURES**

MANIFOLD FILTER HOUSING | PRESSURE TRANSDUCER | SUREFLO™ PUSHER VALVE | PRIME SPRAY VALVE

**LEVEL 6** Hydra® Pro IV, M4000, M2000 **\$1,199<sup>00</sup>**  
CAD \$1,748.00

**LEVEL 3** Impact® 740, 840, 1040, 1140 **\$275<sup>00</sup>**  
CAD \$365.00

## ELITE PROGRAM

**GET A PERMASTROKE KIT**  
at a discounted rate  
when you purchase a qualifying sprayer



**LEVEL 1** Elite™ 3000, 3500;  
PowrLiner 3500 **\$125<sup>00</sup>**  
CAD \$232.00



**CONNECTOR APP**  
Available for download  
[theconnectorapp.com](http://theconnectorapp.com)

Call Technical Services at  
**1-800-526-5362**  
for complete warranty information.

All information contained in this brochure is based on the latest information available at the time of printing. Titan reserves the right to make changes at any time, without notice. Due to continuous innovation, specifications may progressively change. Contact one of our dependable sales reps or call our dedicated customer service team for more information.